



**Segway® HT
reference manual**

- > i Series
- > p Series
- > Segway XT
- > Segway GT

welcome to the evolution of personal mobility.

about this manual

Congratulations on the purchase of your new Segway Human Transporter (HT)! You are about to experience human mobility like you never have before. This manual describes the technology and engineering incorporated into your Segway HT. It also includes information on battery charging, maintenance, and troubleshooting. The Reference Manual does not contain instructions on how to ride the Segway HT.

Use this manual for the following Segway HT models: i Series, p Series, Segway Cross-Terrain Transporter (XT) and Segway Golf Transporter (GT).

To assemble and charge your Segway HT for the first time, follow the separate Assembly Instructions included with your Segway HT. If you don't have the Assembly Instructions for your Segway HT model, contact an Authorized Segway Dealer.

If you have any questions, or need the user materials for any Segway HT model, contact an Authorized Segway Dealer. For a list of Dealers, visit www.segway.com. Check the website for updates to Segway HT user materials: www.segway.com.



the risk of injury

To learn to ride your Segway HT i Series, p Series, Segway XT or Segway GT model, you must read and follow all instructions and warnings in the Riders' Guide and you must watch the Safety Video. If you don't have the Riders' Guide for your Segway HT model or the Safety Video, contact an Authorized Segway Dealer. For a list of Dealers, visit www.segway.com.



WARNING!

RISK OF DEATH OR SERIOUS INJURY

Whenever you ride the Segway HT, you risk death or serious injury from loss of control, collisions and falls. To reduce risk of injury, you must read and follow all instructions and warnings in the Riders' Guide for your Segway HT model and you must watch the Safety Video.



Segway contact information

Segway Customer Operations: 1-866-4SEGWAY (1-866-473-4929).

Fax: 1-603-222-6001

Email: technicalsupport@segway.com.

Website: www.segway.com.

icon legend



WARNING indicates a potentially hazardous situation that, if not avoided, could result in serious injury or death.



notes
Look for this icon for important information.



troubleshooting
Look for this icon for guidance in troubleshooting problems with your Segway HT.

record your serial number and key code

To order replacement Keys, you must have both the Serial Number of your Segway HT, and the Key Code. The Serial Number is the 12-digit number beginning with “0” located on the left side of the bar code label on the rear edge of the Platform.



The Key Code is a 16-digit number located on the bar coded tag included with your Keys.

Record these numbers and store them in a confidential location, separate from your Segway HT.

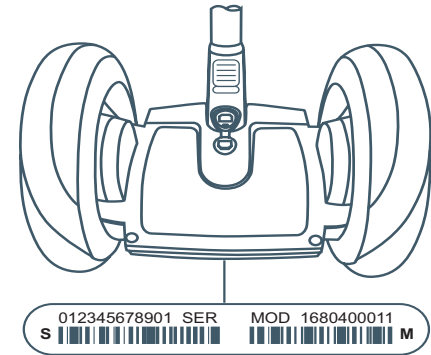

contents

your Segway HT	6
Segway HT specifications.....	7
chapter 1: how the Segway HT works.....	12
chapter 2: helpful hints.....	19
chapter 3: battery packs	22
chapter 4: troubleshooting and display icons.....	29
chapter 5: service	37
chapter 6: frequently asked questions.....	42
chapter 7: contact and legal information	43
index	46

your Segway HT

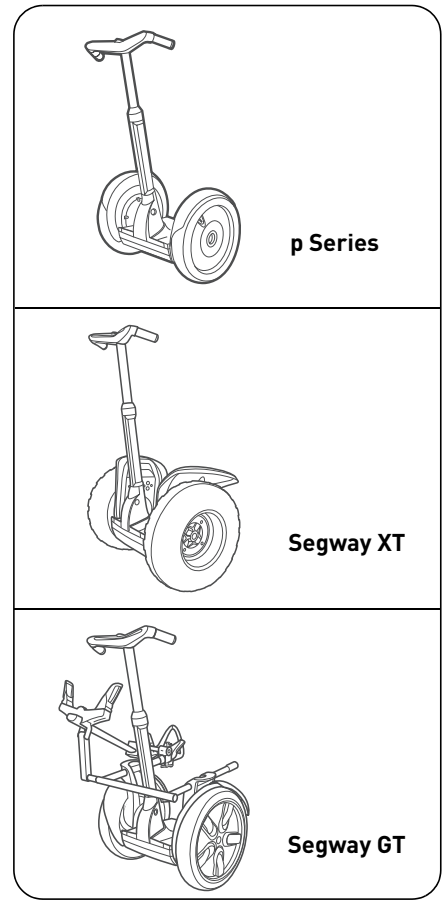
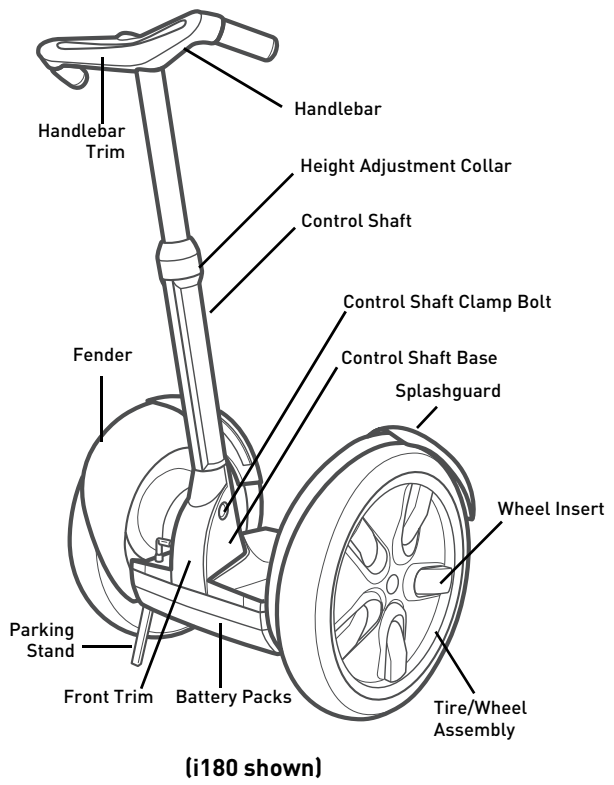
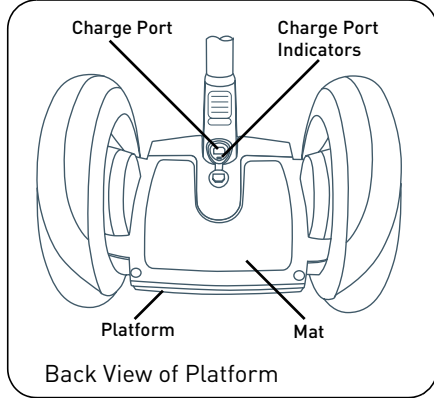
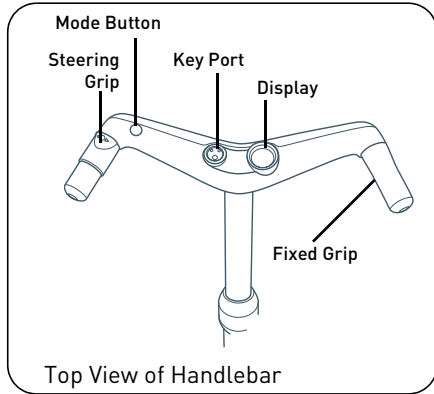

Segway HT specifications

Model Specifications	p Series	i Series	Segway XT	Segway GT
Rider Weight and Cargo Limits *				
max. payload (rider plus all cargo):	210 lbs (96 kg)	260 lbs (118 kg)	260 lbs (118 kg)	260 lbs (118 kg)
min. rider weight:	100 lbs (45 kg)	100 lbs (45 kg)	100 lbs (45 kg)	100 lbs (45 kg)
max. handlebar cargo weight:	10 lbs (4.5 kg)	10 lbs (4.5 kg)	10 lbs (4.5 kg)	10 lbs (4.5 kg)
Performance				
max. speed:	10 mph (16 km/h)	12.5 mph (20 km/h)	12.5 mph (20 km/h)	12.5 mph (20 km/h)
energy (rechargeable battery packs):	NiMH	NiMH or Li-ion	Li-ion	Li-ion
range on a full charge- NiMH: **	6 to 10 mi (10 to 16 km)	8 to 12 mi (13 to 19 km)	NiMH not available	NiMH not available
range on a full charge- Li-ion: **	Li-ion not available	16 to 24 mi (26 to 39 km)	9 to 12 mi (14 to 19 km)	8 to 24 mi (13 to 39 km)
turning radius:	Zero. The wheels can rotate in opposite directions, enabling the Segway HT to turn in place.			
tire inflation pressure:	22 psi (150 kPa)	15 psi (105 kPa)	4 psi (28 kPa)	15 psi (105 kPa)
power requirements (worldwide):	100 to 240 V, 50 to 60 HZ	100 to 240 V, 50 to 60 HZ	100 to 240 V, 50 to 60 HZ	100 to 240 V, 50 to 60 HZ

* See page 9 for information about why Segway sets these weight limits.

** See page 10 to read about maximizing the distance you can travel on your Segway HT, and factors that can increase or reduce your range.

Model Specifications (Continued)	p Series	i Series	Segway XT	Segway GT
Dimensions				
machine weight without battery packs:	55 lbs (25 kg)	68 lbs (29 kg)	82 lbs (37 kg)	74 lbs (33.5 kg)
battery pack weight:	See Battery Pack Specifications on page 23.			
ground clearance (unloaded)- NiMH:	3.0 in (7.6 cm)	4.0 in (10.2 cm)	NiMH not available	NiMH not available
ground clearance (unloaded)- Li-ion:	Li-ion not available	3.0 in (7.6 cm)	4.5 in (11.4 cm)	3.0 in (7.6 cm)
machine length and width:	16 x 22 in (41 x 55 cm)	19 x 25 in (48 x 64 cm)	21 x 30.5 in (53 x 77 cm)	33 x 37 in (84 x 94 cm)
handlebar height:	35.5-48.5 in (90-123 cm)	37-50 in (94-127 cm)	38-51 in (97-130 cm)	37-50 in (94-127 cm)
platform height (unloaded):	6.7 in (17 cm)	8.0 in (20 cm)	9.5 in (24 cm)	8.0 in (20 cm)
tire diameter:	16 in (41 cm)	19 in (48 cm)	21 in (53 cm)	19 in (48 cm)
tire type:	Standard	Standard	All-terrain	Enhanced Traction

Weight Limits for Riders and Cargo

Segway sets weight limits for two reasons: rider safety and to reduce risk of damage to the Segway HT.

Dynamic Weight Limits

To keep the Segway HT and rider upright, the Segway HT must always have enough power to be able to turn its wheels forward and backward. Exceeding the weight limits, especially when combined with other variables that require more power (see list below), will increase your risk of falling or damaging the Segway HT. Variables that require more power include:

- > Higher payloads (weight of rider and all cargo)
- > Steeper slopes
- > Bumpier surface conditions
- > Higher speeds
- > Abrupt maneuvers

Since the Segway HT can monitor the amount of power being used, the Segway HT will engage the Speed Limiter (and potentially perform the Stick Shake Warning) in response to these variables. It is important that all riders learn to anticipate and recognize when the Segway HT is reaching the limits of performance.

Minimum Weight Limit

The rider's weight must not be less than 100 lbs. (45 kg). If the rider is below the minimum rider weight limit, she may not be able to ride safely because she cannot shift her weight far enough back (behind the centerline of the wheels) to safely slow down and stop, especially when riding downhill. Also, riders below the minimum weight limit might fail to properly activate the Segway HT's balancing system.

Handlebar Cargo

The total weight of any Handlebar payload plus any other attachments hanging from the Handlebar should not exceed 10 lbs (4.5 kg). Exceeding this limit interferes with the Segway HT's balancing ability and could cause the Segway HT to accelerate on its own, risking injury and damage.

Structural Weight Limits

Increased risk of damage to the Segway HT is another consequence of exceeding the maximum weight limits. Heavier payloads place greater stresses on the Segway HT. Segway's testing has shown that the stresses created by a payload within the total payload weight limit (with any cargo not exceeding the applicable cargo weight limits), ridden on a wide variety of terrain in accordance with the instructions in the Segway HT Riders' Guide, the Segway HT Reference Manual, and the Segway HT Safety Video, will not damage the Segway HT.

Just like the dynamic weight limits, several factors affect the loads transmitted to the Segway HT:

- > Skill level of the rider
- > Payload (weight of the rider and all cargo)
- > Surface condition (obstacle height, etc.)

The stresses created by exceeding the rider or cargo weight limits, especially when riding on uneven terrain, could damage the Segway HT.

Maximizing Range

Only experienced riders riding in optimum conditions will reach the maximum range distances stated on page 7. The range of your Segway HT is affected by many variables, including:

- > **Terrain:** Riding on smooth, flat terrain improves range; riding on hilly terrain and unpaved surfaces reduces range. For example, the Segway GT's estimated range on a golf course is 8 to 10 miles (13 to 16 km); on pavement, the estimated range is 16 to 24 miles (26 to 39 km).
- > **Speed and Riding Style:** Consistent, moderate speed increases range; frequent starting, stopping, acceleration, and deceleration decreases range.
- > **Tire Inflation Pressure:** Riding with tire pressure below the specified limit reduces range.
- > **Rider Weight and Cargo:** Lighter riders with less cargo get better range than heavier riders with more cargo.
- > **Temperature:** Storing, charging and riding nearest the center of the recommended temperature range improves range. Riding in colder temperatures reduces range significantly.
- > **Battery Pack Condition:** Properly charged and maintained Battery Packs provide greater range; old, cold, heavily used, or poorly maintained Battery Packs provide less range.
- > **Wind:** Tailwind increases range; headwind reduces range.

Model Descriptions

You should first learn to ride using the Beginner Key in an area with no obstructions and a level, smooth riding surface with good traction. See the Riders' Guide and watch the Safety Video for instructions and warnings about learning to ride.

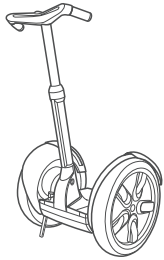

i Series

The i Series model is optimized for indoor/outdoor use in a wide variety of environments. Weight limits, range and top speed are higher than on the p Series model. The i Series may use either two NiMH Battery Packs or two Li-ion Battery Packs. Older i Series models, originally equipped with NiMH Battery Packs, require a software upgrade to switch to Li-ion Battery Packs.

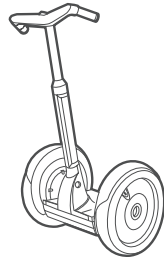

p Series

The p Series model is optimized for indoor/outdoor use in densely populated environments. The p Series model is lighter than other models, has a smaller wheel diameter, Motors, Batteries, and Platform. This model uses NiMH Battery Packs only.

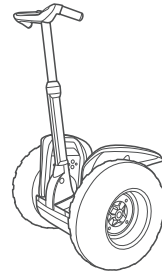

Segway XT

The Segway XT is optimized for outdoor use. The Segway XT has larger wheels and wider tires with knobby treads, and is intended for use on more varied and rugged terrain than other models. The Segway XT's wider stance and low pressure tires provide increased stability and traction on rough terrain. This model uses Li-ion Battery Packs only. The Segway XT is not intended for use on sidewalks.

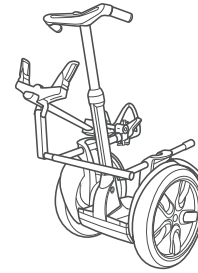

Segway GT

The Segway GT is optimized for use on Golf Courses. It ships with Enhanced Traction Tires, the Golf Bag Carrier kit and Li-ion Battery Packs. The Golf Bag Carrier kit ships in a separate box, which includes additional instructions and warnings for proper installation and use. To reduce risk of injury, be sure to follow those separate instructions when installing and riding with the Golf Bag Carrier.

chapter 1: how the Segway HT works

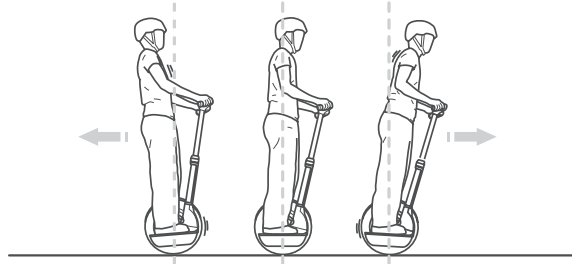

The Segway HT works like the human body. If you lean forward, you take a step forward to keep your balance. If you lean back, you step back. Substitute wheels for feet, and you have an empowered pedestrian on a Segway HT.

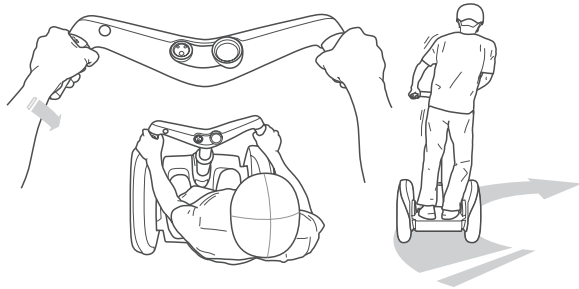

The Segway HT uses technology called dynamic stabilization. When you lean forward, your center of gravity moves forward of the contact patch (the place where the tire contacts the ground) causing the Segway HT to tilt forward. The Segway HT's systems sense this change (measuring 100 times per second), and power the wheels to keep them underneath you. The Segway HT's technology balances forward and backward but not side-to-side. That means that if the rider tilts the Segway HT onto one wheel, it will not dynamically bring itself underneath the rider. It could fall over. The rider is responsible for dynamically stabilizing laterally while riding the Segway HT. Leaning into turns and leaning uphill when riding across a slope are the rider's responsibility (see the Riders' Guide for details).

Redundant Subsystems

The Segway HT has been designed with the utmost concern for the safety of the rider and those who may be nearby. Redundant subsystems are provided to maintain controlled operation of the Segway HT in the unlikely event of a component failure. If one of the redundant components fails, the other component continues to operate, bringing the rider to a safe stop. Five of the subsystems in the Segway HT are designed with a redundant architecture: Controller Boards, Motors, Battery Packs, the Balance Sensor Assembly, and Handlebar Electronics.

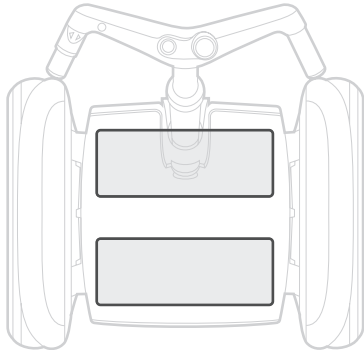

> Controller Boards

The two Controller Boards receive input from the gyroscopes and other sensors, and from the Handlebar Electronics. They also monitor battery condition. The Controller Boards send commands to the Motors. The Controller Boards are interchangeable. They are connected to the Control Shaft Cords, the Balance Sensor Assembly, the Batteries, and the Motors, so that if there is a malfunction in any of these components or the connections between them, the Segway HT will perform a Safety Shutdown.

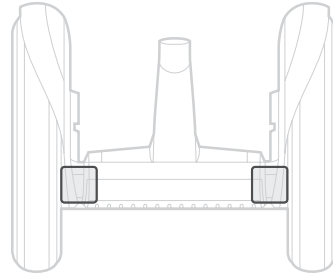

> Motors

Each wheel is independently driven by redundant, high-speed electric Motors that produce no pollution emissions. The brushless design employs computer technology to precisely regulate motion. The Motors have been tested to power levels of two horsepower. Each Motor is wound as two separate electrical circuits, capable of independent operation, acting as one mechanical entity.

The Motor for each wheel (right/left) is connected to the front and rear drive systems. This allows either the front or the rear drive system to produce torque on the Motor shaft. The system uses independent controllers for the front and rear drive systems. If either Motor fails, the Segway HT will perform a Safety Shutdown.

	For information about Safety Shutdown, see page 17.
---	--

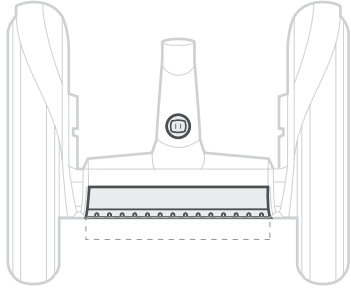

> Battery Packs

The two Battery Packs are sealed units that require no maintenance besides proper charging and storage. Either Battery Pack can be installed in the front or back of the Platform. Both Battery Packs must be of the same chemistry (for example, you cannot mix one NiMH Battery Pack with one Li-ion Battery Pack). Li-ion Battery Packs are larger than NiMH Battery Packs. If either Battery Pack fails, the Segway HT will perform a Safety Shutdown.

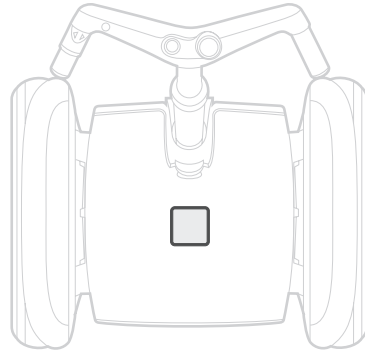

> Balance Sensor Assembly

The Balance Sensor Assembly contains five angular rate sensors (solid state gyroscopes) and two tilt sensors. These sensors gather information about the orientation of the Platform in all three planes (pitch, roll, and yaw). This information is sent to the Controller Boards. All five of the rate sensors are constantly checking each other to ensure each is operating correctly. The two tilt sensors check each other in the same manner. If any of these sensors fails, the Segway HT will perform a Safety Shutdown.

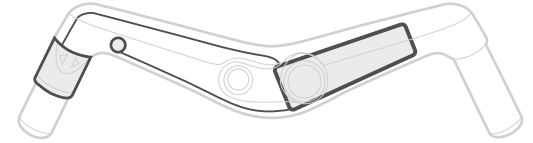

> Handlebar Electronics

The Handlebar contains redundant communication systems and redundant sensors in the Steering Grip and Mode Button. If there is a malfunction in either the Steering Grip or Mode Button sensors, or any of the other electronics in the Handlebar, the Segway HT will perform a Safety Shutdown. Each system in the Handlebar communicates information to the Controller Boards via an independent Control Shaft Cord. If either cord malfunctions, the Segway HT will perform a Safety Shutdown.



For information about Safety Shutdown, see page 17.



WARNING!

Read and follow all the instructions in the Riders' Guide and watch the Safety Video for important safety information about Speed Limiter, Stick Shake and Safety Shutdown.

Speed Limiter

The Segway HT will push its Handlebar back to slow the rider down. The speed at which the Segway HT pushes the Handlebar back depends on a variety of factors including riding style, terrain, payload, the Key used to start the Segway HT, Battery Pack condition, and other factors (see list at right). When you reach the maximum allowed speed, based on these factors, the Segway HT will push the Handlebar back to slow you down. This is called the Speed Limiter.

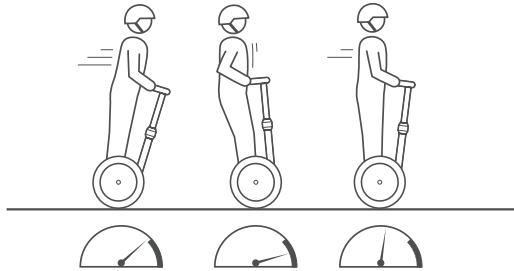

The speed at which the Speed Limiter will tilt the Handlebar back depends upon the Key used to power on the Segway HT. Other conditions may cause the Speed Limiter to tilt the Handlebar back at slower than the maximum Key speeds. These conditions include:

- > **Riding up a steep hill.**
- > **Riding on bumpy terrain.**
- > **Low Battery Pack charge.**
- > **Riding down a hill with fully charged Battery Packs. (Because of regenerative charging, if the Battery Packs are fully charged, the Segway HT will engage the Speed Limiter to avoid overcharging.)**
- > **The first few seconds after power on.**
- > **Inadequate foot pressure on the Platform.**
- > **The Battery Packs are too hot or too cold.**

When the Segway HT reduces performance, the Display will show the following:

Display Icon	 (green)
Definition	The Segway HT is operating at reduced performance levels due to a temporary condition. The speed limit has been lowered until the condition clears.
User Response	If you feel the Speed Limiter push the Handlebar back, stop leaning forward and slow down. You should always leave a gap between yourself and the Handlebar. Riding against the Handlebar can cause loss of control, collisions, falls and injury.

Stick Shake Warning

One of the ways the Segway HT notifies you that you are at risk of falling is by shaking the Handlebar and making growling noises. This is called the Stick Shake Warning. The Stick Shake Warning will occur if you ride backward too fast or if you demand too much power from the Segway HT, such as by riding on a steep slope, on rough terrain, against an obstacle or by accelerating or decelerating abruptly. Stick Shake Warning is more likely to occur when your Battery Packs are low, cold, heavily used, or poorly maintained. Stick Shake Warning can happen both when you are on and off the Segway HT, as described in the following table:

Action	User Response
Riding aggressively, accelerating or stopping abruptly.	Ease up! Ride more gently, smoothly and slowly.
Riding against the Handlebar.	Ease up! Leave a gap!
Riding on rough terrain or steep slopes.	The terrain is too demanding or steep. Ride on smoother, flatter terrain. If on a slope, turn perpendicular to the slope, step off, and proceed in Power Assist Mode.
Riding against an obstruction.	Stop pushing against the obstruction. Stop, step off, and proceed in Power Assist Mode.
Riding backward.	Stop, turn in place, and proceed forward.
During Safety Shutdown.	Come to a controlled stop and safely step off within 10 seconds.
Moving a Segway HT with no rider on the Platform while in Balance Mode.	When moving your Segway HT in Balance Mode with no rider on the Platform, you must move very slowly, or switch to Power Assist Mode. [See Rider Detection on page 18 for more detail.]
Stepping on the Platform while in Power Assist Mode.	Remove your foot. Level the Platform. Tap the Mode Button to enter Balance Mode. Check the Display for the green smiling face. Move the Handlebar to make sure that the wheels respond. Try stepping on again.

Safety Shutdown

If the Segway HT detects a fault in any of its redundant subsystems, the Segway HT notifies you by automatically reducing its speed, shaking its Handlebar, making growling and beeping noises, and flashing red in the Display. This is called Safety Shutdown.

Display Icon	 (red)
Definition	The system has detected a critical error and is slowing to zero speed before shutdown (full battery charge level indicator shown).
User Response	Come to a controlled stop, then safely step off and discontinue operation. You have approximately 10 seconds from the start of the Safety Shutdown to come to a controlled stop and safely step off.

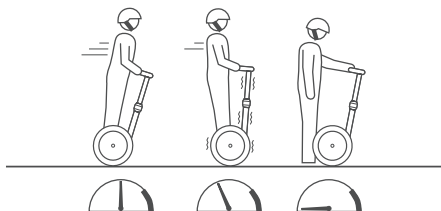

If a Safety Shutdown occurs:

1. Immediately come to a controlled stop.
2. Carefully step off one foot at a time.
3. Do not resume use of your Segway HT until the fault condition is diagnosed and cleared.

Theft Detection Systems

Theft detection systems, such as the type used in some libraries and retail stores, may interfere with Segway HT operation. Some theft detection systems cause the Segway HT to perform a Safety Shutdown. Do not ride within 5 feet (1.5 meters) of any theft detection system. See page 31 for more information.

Empty Battery Condition

The Segway HT will notify you of a pending empty battery condition prior to initiating Safety Shutdown. A red unhappy face icon will appear in the Display, the Segway HT's speed will be limited, and the Segway HT will beep. In some cases, old, cold, heavily used, or poorly maintained Battery Packs may develop a high resistance condition, which could cause the Display to show the

pending empty battery condition even though the Battery Packs were recently charged. Whenever you see the pending empty battery condition icon in the Display, you should come to a controlled stop and safely step off of the Segway HT prior to commencement of the Safety Shutdown. This icon will be shown in the Display:

Display Icon	 (red)
Definition	Pending empty battery condition
User Response	Come to a controlled stop and safely step off of the Segway HT prior to commencement of Safety Shutdown

Never restart and ride your Segway HT after it has indicated an empty battery condition or performed Safety Shutdown due to low battery. The Segway HT may not have enough power to keep you balanced, especially if you demand a lot of power at once. If you restart and continue riding, you risk falling. Also, you risk damaging your Battery Packs, resulting in reduced Battery Pack life and capacity. Fully recharge your Battery Packs within the recommended charging temperature range prior to riding. If the condition persists, contact an Authorized Segway Dealer.

Rider Detection

The Segway HT Platform contains four Rider Detect sensors (beneath the Mat), which detect the presence or absence of a rider while the Segway HT is powered on.

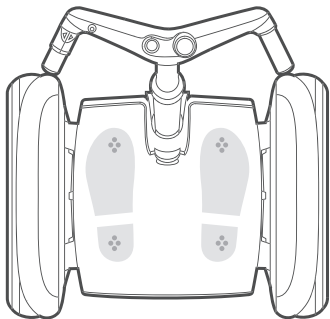

WARNING!

Never place anything on the Platform, except your feet. Doing so could defeat the Rider Detection safety feature, and allow the Segway HT to travel on its own, risking running into a person or property and causing injury or damage.

Make sure to press four

When a rider (weighing 100 lb./45 kg. or more) is aboard with feet properly positioned on the Platform, all four Rider Detect sensors are depressed, and allow the Segway HT to operate normally in Balance Mode. If fewer than three Rider Detect sensors are depressed while riding, the Segway HT will reduce the top speed limit regardless of the Key used. If the Segway HT is in Balance Mode, but none of the Rider Detect sensors are depressed, and the Segway HT is moved too quickly, the Segway HT will give the Stick Shake Warning after moving some distance, and will switch to Power Assist Mode. This response is intended to prevent a riderless Segway HT from traveling on its own. You should never let go of your Segway HT while it is in Balance Mode.

Mode Button

There is only one button on the Segway HT Handlebar. It is called the Mode Button and has three distinct functions:

1. Change from Power Assist Mode to Balance Mode.
2. Change from Balance Mode to Power Assist Mode.
3. Power off from either Power Assist Mode or Balance Mode.

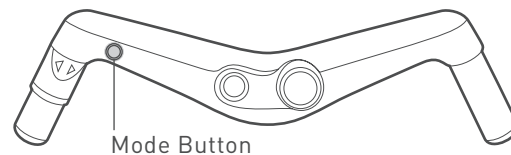

See the Riders' Guide for more information regarding the Mode Button.



When you are riding the Segway HT, the Mode Button is disabled. This is to prevent accidentally powering off or accidentally switching to Power Assist Mode while riding.

chapter 2: helpful hints



Check the Tire/Wheel Assembly

Before each ride, check to make sure the Tire/Wheel Assembly does not wobble and both Wheel Nuts are tight. Grasp the Tire/Wheel Assembly and attempt to move it side-to-side to check for Wheel wobble. The Tire/Wheel Assembly should not move laterally. If you detect Wheel wobble, check the Wheel Nut and tighten if necessary. See page 40 for additional information regarding service procedures for the Tire/Wheel Assembly.

Tire Inflation Pressure

The Tires on the Segway HT serve two important functions, suspension and traction. Both functions are affected by the Tire inflation pressure.

Check Tire inflation pressure regularly. Ensure that Tires are properly inflated to the pressure stated on the label attached to the Wheel (near the inflation valve). Check that both Tires are inflated equally and are free of debris or contaminants.

WARNING!

The Tire pressure stated on the Wheel label (near the inflation valve) supersedes any recommended pressure stated on the Tires.

- > **Higher pressure reduces suspension performance and traction, and increases risk of loss of control, collisions, and falls.**
- > **Lower pressure reduces range and increases risk of damage to the Tire/Wheel Assembly.**
- > **Unequal pressure causes the Segway HT to turn in the direction of the lower pressure Tire.**

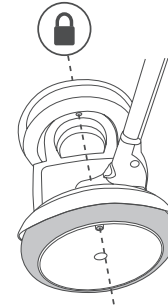

Security

The best way to deter theft of your Segway HT is to store it in a secure indoor location with the Keys stored separately. If you must leave your Segway HT unattended in a location that is not secure, you may use a cable lock threaded through the Wheel. Secure the lock around an appropriate fixed object. However, a thief can always remove the Wheel and Fender or cut or break the lock and steal your Segway HT. No lock is theft proof.

Do not leave your Keys with the Segway HT.

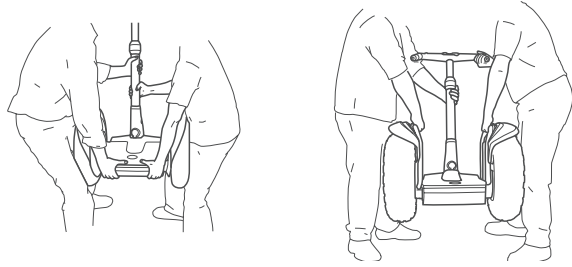

Lifting and Loading

Use safe and appropriate loading and lifting techniques. Make sure the Segway HT is powered off prior to lifting. Segway recommends that two people work together to lift the Segway HT. Each person should place one hand on the Control Shaft (below the Height Adjustment Collar). Each person should place the other hand under the Platform or, with the Segway XT, use the Lifting Handles on the Fender Frames. Lift with your legs, not your back.

Keep Wheel Inserts Installed

Some Standard and Enhanced Traction Tire/Wheel Assemblies contain Wheel Inserts. See illustration on page 6. For these Wheels, you can choose different styles to customize your Segway HT. To reduce risk of injury from the Wheel openings, make sure the Wheel Inserts are properly installed.

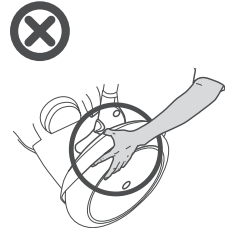

Watch Your Fingers

Never lift the Segway HT by its Tires, Fenders, or Wheels because your hands or fingers could become caught between the Tire and the Fender, resulting in injury.

Storage

To avoid permanent damage to the Battery Packs, you must fully charge the Battery Packs at least once every month, even when your Segway HT is in storage.

Store your Segway HT (and its Battery Packs) indoors, in a place that is dry and free of moisture, humidity, and temperature extremes. Even if you will not be using your Segway HT for an extended period of time, you should leave it plugged into AC power. Otherwise the Battery Packs could fully discharge over time, causing them damage.

Remain within the recommended operating, charging, and storage temperature ranges (see page 23) to preserve the full performance capabilities of the Segway HT Battery Packs.

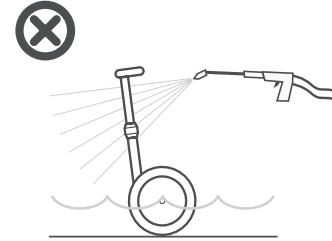

Avoid Submersion

Do not submerge the Battery Packs or Platform in water. Do not wash the Segway HT with a power washer or high pressure hose. Avoid getting water in the Charge Port. Always close the Charge Port Cover after charging.

Avoid exposure to heavy downpours or extended periods of heavy rain (including during riding, storage, or while being transported.) If your Segway HT has been exposed to a heavy downpour or an extended period of rain, remove the Handlebar/Control Shaft Assembly (see page 38). To reduce risk of water damage to the Handlebar electronics, make sure you do not tip the machine forward. Inspect for water in the Control Shaft Base. If water is present, tip the Platform forward to drain, and allow to dry. After ensuring there is no water present in the Control Shaft Base or Control Shaft Cord Connectors, reinstall your Handlebar/Control Shaft Assembly (see page 39).

See page 41 for cleaning instructions.

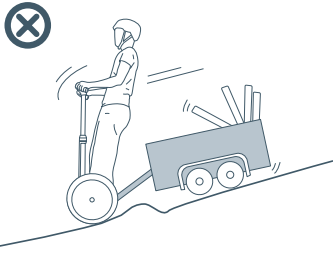

Do Not Tow Anything With Your Segway HT

Although your Segway HT is versatile, you should not attempt to tow or push anything with it. If you try to tow a trailer or other item, you may not be able to stop in a safe manner, turn effectively, or handle various terrain features.

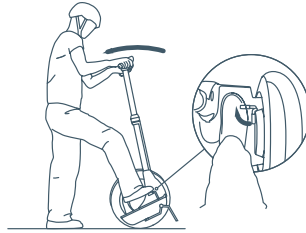

Using the Parking Stand (i Series only)

To deploy the Parking Stand:

1. Make sure the power is off.
2. Tilt the Segway HT back toward you.
3. Turn the lever at the right front corner of the Platform to the left until it is perpendicular to the Fender.
4. Move the Handlebar forward until the Segway HT rests on the Parking Stand. The Platform will be tilted backward to discourage anyone from stepping on.

To retract the Parking Stand:

1. Make sure the power is off.
2. Tilt the Segway HT back toward you.
3. Turn the lever at the right front corner of the Platform to the right until it is parallel to the Fender.

Reminders:

- > Make sure you power off before tilting the Segway HT back toward you. Do not tilt the Segway HT back toward you when in Balance Mode. This could cause the Segway HT to back up into you and could cause injury.
- > Retract the Parking Stand before you attempt to stand on or move the Segway HT.
The Parking Stand will support only an unloaded Segway HT and may break (or cause a fall) if you attempt to stand on or move the Segway HT with the Parking Stand deployed.
This is a safety feature to reduce risk of injury from operating a Segway HT with the Parking Stand deployed.
- > Use the Parking Stand on relatively level ground. It will not work on a slope.

chapter 3: battery packs

Safety Guidelines

Follow the instructions in this manual carefully for your own safety, the safety of others, and to maximize battery life and performance.



Related Documents

The information in this chapter provides a basic understanding of Segway HT Battery Packs. For more advanced information, and for more experienced riders, read the complementary document, "Battery Care Booklet" posted at www.segway.com/support/docs.

Transportation and Shipping

If you are transporting your Segway HT, protect the Battery Packs to avoid damage during shipment. Do not expose the Battery Pack to direct heat or moisture, and avoid heavy vibration during transportation.

If the casing of a Battery Pack breaks open, leaks any substance, becomes excessively hot, or if you detect an unusual odor, do not use or transport the Battery Pack. Do not handle a damaged or leaking Battery Pack unless you are wearing disposable rubber gloves, eye protection, and are in a well-ventilated area. Dispose of the rubber gloves and damaged Battery Pack properly in accordance with regulations governing disposal of toxic materials.

Shipping Li-ion Battery Packs (on or off your Segway HT)

Li-ion Battery Packs are considered "Hazardous Materials" under shipping regulations.

You may ship your Segway HT by ground or sea with Li-ion Battery Packs installed. You cannot ship your Segway HT by air with Li-ion Battery Packs installed. You cannot ship your Li-ion Battery Packs separately from your Segway HT by any means of transport.

If you need to arrange air shipment of your Segway HT with Li-ion Battery Packs installed, or if you need to arrange shipment of your Li-ion Battery Packs separate from the Segway HT by any means of transport, contact an Authorized Segway Dealer for detailed information on shipping of hazardous materials.

	Ground	Sea	Air
Battery Packs Installed	Allowed	Allowed	Not allowed. "Hazardous Materials" regulations apply. *
Battery Packs Not Installed	Not allowed. "Hazardous Materials" regulations apply. *		

* Contact an Authorized Segway Dealer.



WARNING!

Do not use the Battery Pack if the Battery Pack casing is broken or if a Battery Pack emits an unusual odor or excessive heat or leaks any substance. Avoid contact with any substance seeping from the Battery Pack.

Keep out of reach of children and pets. Exposure to Battery Pack voltage could result in death or serious injury.

Unplug and disconnect your Segway HT from AC power before removing or installing Battery Packs or performing any service. It is hazardous to work on any part of your Segway HT when it is plugged into AC power. You risk serious bodily injury from electric shock as well as damage to your Segway HT.

The cells within the Battery Packs contain toxic substances. Do not attempt to open Battery Packs. Do not insert any object into the Battery Packs or use any device to pry at the Battery Pack casing. If you insert an object into any of the Battery Packs' ports or openings you could suffer electric shock, injury, burns, or cause a fire. Attempting to open the Battery Pack casing will damage the casing and could release toxic and harmful substances.

Battery Pack Specifications

Segway HT Battery Pack Type	NiMH- 60 Cell (i Series)	NiMH- 48 Cell (p Series)	Li-ion - 92 Cell
Charging Time			
before first use:	Important! 12 hours. As soon as possible and before your first use, charge the Battery Packs for at least 12 hours.		
first five uses (discharge 50% or less):	8 hours	8 hours	not applicable
recharge from empty:	~6 hours	~6 hours	~8 hours
Temperature Ranges			
operating:	32°F to 122°F (0°C to 50°C)	41°F to 122°F (5°C to 50°C)	14°F to 122°F (-10°C to 50°C)
charging:	41°F to 77°F (5°C to 25°C)	41°F to 77°F (5°C to 25°C)	14°F to 122°F (-10°C to 50°C)
storage and transport:	-4°F to 122°F (-20°C to 50°C)	-4°F to 122°F (-20°C to 50°C)	-4°F to 122°F (-20°C to 50°C)
General			
capacity (Ah) and voltage:	3.0 Ah, 72 volts	3.0 Ah, 60 volts	5.8 Ah, 72 volts
dimensions:	14 x 6.1 x 2.3 in (35.7 x 15 x 5.7 cm)	13.4 x 4.9 x 2.3 in (34 x 12.3 x 5.7 cm)	14 x 7.5 x 3.2 in (35.7 x 19 x 8.2 cm)
battery pack weight (pair):	19 lbs (8.6 kg)	15 lbs (6.8 kg)	22.7 lbs (10.3 kg)



If you use, charge or store your Segway HT Battery Packs outside these conditions, you may void the limited warranty, damage your Battery Packs, and/or experience reduced range and ineffective battery charging. For more advanced information regarding operating, charging and storing your Battery Packs, read the Battery Care Booklet posted at www.segway.com/support/docs.

To Charge Your Battery Packs

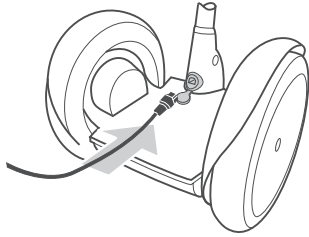

In order to maintain the best performance from your Segway HT Battery Packs, fully charge your Battery Packs for at least twelve hours, once a month, or once every twelve hours of operation— whichever comes first. Make sure that your Battery Packs are within the specified charging temperature range when charging.

Even if you do not intend to immediately use your new Segway HT, you should still charge the Battery Packs for at least twelve hours as soon as possible.

1. Make sure the Charge Port is dry. Do not insert the plug if it is wet.
2. Plug one end of the Power Cord (provided with your Segway HT) into the Charge Port in the Control Shaft Base.
3. Plug the other end of the Power Cord into a grounded AC outlet (100 V to 240 V; 50 Hz to 60 Hz). The Power Cord should be properly grounded.

Remember to charge your Segway HT whenever it is not in use.

You do not need to worry about overcharging, so you should always plug your Segway HT into AC power when it is not in use. Even if you will not be using your Segway HT for an extended period of time, you should leave it plugged into AC power. Otherwise, the Battery Packs could fully discharge over time, causing them permanent damage.

Do not store your Segway HT or Battery Packs for more than one month without fully charging the Battery Packs at least once every thirty days. This could cause permanent damage to the Battery Packs.

Before Each Ride—Remember to Close the Charge Port Cover

Close the Charge Port Cover except when you are charging the Segway HT. Closing the Charge Port Cover will prevent water, dirt, dust, and other contaminants from entering through the Charge Port and causing damage to your Segway HT.

Limit NiMH Battery Pack Discharge for the First Five Uses

To maximize NiMH Battery Pack life and performance, follow this procedure to charge and condition your new NiMH Battery Packs before the first use and after the first five uses:

1. **As soon as possible and before your first use, charge the Battery Packs for at least twelve hours.**
2. Limit the duration of the first five uses of your Segway HT so that you do not discharge the Battery Packs below the charge level illustrated below. For information about the battery charge level display, see page 26.



3. After each of your first five uses, charge the Battery Packs for at least eight hours.

Charging Indicators

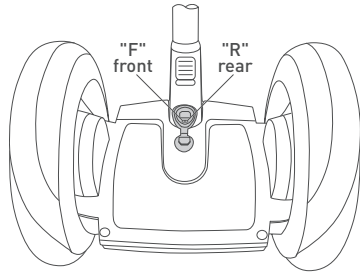

The Control Shaft Base has two LED (Light Emitting Diode) charging indicators located below the Charge Port.



The left charging indicator corresponds to the front Battery Pack, the right to the rear Battery Pack. They are marked "F" and "R," respectively. The charging indicators provide independent information regarding whether each Battery Pack is charging.

When a green LED is on, the respective Battery Pack is receiving a pulse of current. Slow pulse rates are slow charging rates, faster rates denote faster charging, and solid green is the maximum charge rate.

Charging Process

The following table describes the charging process for NiMH and Li-ion Battery Packs. The length of each stage in the process, and the signals from the charging indicators, will vary based on the following:

- > Battery Pack type: Refer to the following table to learn what the charging indicators signify.
- > Amount of charge already stored in the Battery Pack: The lower the Battery Charge Level is, the longer it will take to complete the charging process.
- > Battery Pack temperature: If the Battery Packs are too hot or too cold, they may not charge, may not progress through the charging stages, or may take much longer to charge. The Battery Packs will charge most efficiently when they are nearest the center of the recommended charging temperature range (see page 23).

Stage	Li-ion Battery Packs	NiMH Battery Packs
Initial Test	Battery Pack immediately proceeds to "Fast Charge" 	Slow green pulse. Lasts for approximately 2 minutes. - - - - -
Fast Charge	Solid green LEDs. The majority of charging takes place during this stage. —————	Solid green LEDs. The majority of charging takes place during this stage. —————
Cell Balancing	Green pulse; slows down over time. Lasts a few minutes to several hours, depending on how much balancing the cells require. - - - - -	Fast green pulse. Lasts approximately 3 hours. - - - - -
Fully Charged	LEDs are unlit for approximately 5 minutes.	Battery Pack immediately proceeds to "Battery Maintenance" stage. 
Battery Maintenance	Several fast green pulses every few seconds. - - - - -	Slow green pulse. - - - - -

Charging Failures

If a failure is detected during charging, all charging will stop. Depending on the nature of the failure, a solid red charging indicator light will be displayed or the charging indicator will be off. (For Li-ion Battery Packs, the charging indicators will be unlit for approximately 5 minutes after the Cell Balancing stage. See page 25.)

If either or both charging indicators are off or red, do this:

- > If the charging indicators are off (no illumination), check to make sure that AC power is present.
- > If AC power is present and the charging indicators are either red or off, unplug the power cord, then remove and reseat the Battery Pack(s), following the instructions beginning on page 39.
- > If this does not resolve the problem, contact an Authorized Segway Dealer. For a list of Dealers, visit www.segway.com.

NiMH Battery Packs are Particularly Sensitive to Proper Charging Temperatures

If your NiMH Battery Pack is too hot or too cold, the charging indicator will continue to blink, indicating a slow or trickle charge, until the battery temperature is within the charging temperature range. Once stabilized within this range, the fast charge will begin and the charging indicator will be solid green.

If the charging indicator lights remain blinking throughout the entire time that the Segway HT is

plugged in, then the Battery Packs have trickle-charged the entire time. This will provide only a small amount of energy into the Battery Packs.

If you are concerned that the NiMH Battery Packs are too hot or too cold during charging:

- > Check the charging indicators to make sure they show solid green, indicating fast charge.
- > If the charging indicators do not show solid green within 15 minutes after the Segway HT is plugged in, move the Segway HT to a location within the recommended charging temperature range (see page 23).
- > After the Battery Packs are within the recommended temperature range, reconnect the Power Cord.
- > If the charging indicators still do not show solid green within 15 minutes, contact an Authorized Segway Dealer. For a list of Dealers, visit www.segway.com.

In hot conditions, you can improve charging by:

- > Moving the Segway HT or off board charging unit out of the sun, or off of hot asphalt (into an air-conditioned environment is best).
- > Placing a fan near the Segway HT or off board charging unit to blow air over the batteries.

Battery Charge Level Display

The dashed ring around the perimeter of the Handlebar Display indicates the battery charge level. The following series of displays illustrates a gradually depleting battery charge while in Balance Mode:



This series of displays illustrates the same battery charge levels while in Power Assist Mode:



The Segway HT displays intermediate battery charge levels using flashing segments (e.g., a battery at approximately 90 percent displays a flashing top bar). If the battery charge level is very low, the Segway HT will notify you of a pending empty battery condition prior to initiating Safety Shutdown (see page 17). Do not ride your Segway HT if there is inadequate charge in the Battery Packs (indicated by the red unhappy face icon in the Display and no segments around the perimeter). Carefully monitor your Display and be prepared to step off if your battery charge becomes completely depleted.

The battery charge level display shows the relative charge level. No battery gauge is accurate enough to predict exactly when your battery charge will be totally depleted. It is best to keep track of your battery charge level and recharge whenever possible.

In certain situations, such as riding uphill, the battery charge level display may temporarily drop because you are drawing heavily on the Battery Packs. The battery charge level display should return to the actual charge level once you return to level ground and reduce the load on the Battery Packs.

Regenerative Braking

The Segway HT has a regenerative braking system that charges the Battery Packs when descending a hill or slowing down, or when you push or pull the Segway HT while in Power Assist mode (without using the Steering Grip for power).

When you ride down a hill, you may notice an increase in the battery charge level. If your Battery Packs are already completely full at the top of a hill, when you descend, you may feel the Speed Limiter engage (see page 15).

Surface Charge

Whenever you do not fully charge the Segway HT's Battery Packs (or most batteries, for that matter), there is a possibility of surface charge affecting the accuracy of the battery charge level display. This could cause the Display to falsely show a greater charge level.

After you power on, check the battery charge level display, then ride for at least three or four minutes and check the battery charge level display again. If the battery charge level display shows rapid charge depletion during these three or four minutes, you should conclude that the Battery Packs had only a surface charge. If required, plug the Segway HT back in and recharge.

Recalibrating the Battery Charge Level Display for Li-ion Battery Packs

The Segway HT indicates the battery charge level in the Handlebar Display, as described above (see page 26). When using Li-ion Battery Packs the Display may be inaccurate after long periods of storage, or during initial use. To recalibrate the Display:

1. Fully charge the Battery Packs for twelve hours.
2. Discharge the Battery Packs until the bottom bar in the Display is blinking (approximately 10 percent Battery Pack charge remaining).

To safely discharge to this level, you may leave your Segway HT powered on in Balance Mode, leaning against a wall. Make sure to do this in a safe, secure location.



3. Fully recharge the Battery Packs for a minimum of ten hours, after which the Battery Charge Level Display will be recalibrated.

Temperature Affects Performance

The Battery Packs will generally be significantly warmer than the air temperature due to heating that occurs as electricity is delivered from them (while riding) and to them (while charging.)

Riding in Hot or Cold Temperatures

The Battery Packs will run at the highest capacity when you operate them nearest the center of the recommended operating temperature range.

If the Battery Packs on your Segway HT become too hot or too cold while riding, the Segway HT may reduce performance (Display icon with straight mouth, Speed Limiter and possibly Stick Shake Warning) or perform Safety Shutdown. Ease up. If performance does not return to normal, stop riding and allow your Battery Packs to warm or cool to within the recommended operating temperature range.



(green)

If the Battery Packs are too hot or too cold while riding, the Segway HT will reduce performance (see page 34). The Display will show the reduced performance icon. (Note that the face is not smiling.)

As with all batteries, less energy is available at low battery temperatures. You may not be able to travel the same distance when the Battery Packs are cold, as when the Battery Packs are nearer to room temperature.

Charging in Hot or Cold Temperatures

Your Battery Packs should be within the recommended charging temperature range prior to and during charging (see page 23). The Battery Packs will charge most efficiently when they are nearest the center of the recommended charging temperature range.

If your Battery Packs are too hot or too cold, they may take longer to charge, or they may not charge at all.

If you are concerned that the Battery Packs may be too cold or overheated during charging, refer to Charging Failures on page 26.

Replacing Battery Packs

Battery Packs should last the equivalent of 300 to 500 full charges. As your Battery Packs near the end of their useful life, they need more frequent charging and your Segway HT's range will be reduced. To order replacement Battery Packs, contact an Authorized Segway Dealer. For a list of Dealers, visit www.segway.com.

Use the Same Battery Pack Types

Your Segway HT is powered by two rechargeable Battery Packs. The p Series model uses two 48-cell NiMH Battery Packs. The i Series model uses either two 60-cell NiMH or two Li-ion Battery Packs. The Segway XT and the Segway GT models use two Li-ion Battery Packs.

Do not mix Battery Pack types. Always use Battery Packs in pairs of the same chemistry, for example, two NiMH or two Li-ion Battery Packs. If two Battery Packs of different chemistry type are installed on the same machine, you will be unable to operate your Segway HT, and you will see the following Display when you attempt to power on:



(red)

Replace Battery Packs in Pairs

Whenever you replace a Battery Pack, consider replacing both Battery Packs, and always use pairs of Battery Packs with the same chemistry. Replacing only one Battery Pack will not necessarily increase the performance or range of your Segway HT, because the Segway HT is designed to operate only at the level allowed by the lower-energy Battery Pack.

Redundancy is a critical safety feature built into the Segway HT. This applies to the Battery Packs. Therefore, you should replace Battery Packs in pairs (except for the unusual situation where a Battery Pack is replaced because of damage or defect and the other Battery Pack is relatively new).

See instructions for removing and installing Battery Packs, beginning on page 39.

chapter 4: troubleshooting and display icons



Before contacting an Authorized Segway Dealer, you may attempt to troubleshoot certain problems yourself. Refer to the Display Icons on the Handlebar (beginning on page 32) for information about the operational mode of the Segway HT (Power Assist Mode or Balance Mode), the battery charge level, and fault conditions. If following these steps and referring to the Display Icon information does not solve the problem, contact an Authorized Segway Dealer. For a list of Dealers, visit www.segway.com.

Problem	Segway HT will not power on.
	<ol style="list-style-type: none">1. If you see a red icon in the Display when attempting to power on, refer to the Startup Error Conditions on page 32.2. Press the Key fully into the Key Port using gentle, constant pressure to keep the Key in contact with the three metal contacts in the Key Port. Do not push down hard on the Key. This could damage the Key and/or the Key Port.3. Hold the Key against the contacts for at least three seconds. You should hear a beep and see that the Display is orange.4. If the Segway HT does not power on, try a variety of Key positions and wait three seconds with the Key held in each position. Do not “rock” the Key in the Key Port.5. If the Segway HT still will not power on, you may need to reset the system by disconnecting and reconnecting the Control Shaft Cords (see instructions beginning on page 38) and then power on. The 5 mm hex wrench is required for this procedure. You may wish to carry this wrench with you in the event a reset is required.6. If the Segway HT still will not power on, remove and reseal both Battery Packs (see instructions beginning on page 39), and then power on.7. If the Segway HT still will not power on, charge the Battery Packs (see page 24) and then power on.

Problem	Segway HT will not enter Balance Mode.
	<ol style="list-style-type: none">1. Confirm you powered on into Power Assist Mode (see the Riders’ Guide).2. Confirm you are following all the steps listed in the Riders’ Guide for entering Balance Mode, including making sure the Platform is level when you tap the Mode Button.3. Check the icon in the Display against the messages described on pages 32–36.4. If a display icon appears, follow the “User Response” described on pages 32–36 to attempt to clear the fault.

Problem	The entire Handlebar/Control Shaft Assembly turns within the Control Shaft Base.
	<ol style="list-style-type: none">1. Tighten the Control Shaft Clamp Bolt (see page 39).2. If the Control Shaft Clamp Bolt will not tighten and remain tight, inspect all three Control Shaft Clamp parts for damage.3. If any part is damaged, contact an Authorized Segway Dealer to order a replacement Control Shaft Clamp Kit.4. If none of the Control Shaft Clamp parts are damaged, check to make sure the Control Shaft is properly seated into the Control Shaft Base (see page 39).

Problem	The Tire/Wheel Assembly is loose and wobbles.
	<ol style="list-style-type: none"> 1. Tighten the Wheel Nut (see page 40). If the Tire/Wheel Assembly is still loose or wobbles, proceed to step 2. 2. Remove, clean, and reseat the Tire/Wheel Assembly (see page 40).

Problem	Segway HT pulls to the left or right when riding.
	<ol style="list-style-type: none"> 1. Check to make sure tire inflation pressure is equal in both tires. 2. Check to make sure the Steering Grip returns to center. If the Segway HT turns in place without the rider turning the Steering Grip, the Steering Grip is not returning to center. The rider may need to twist the Steering Grip slightly to return it to center.

Problem	Tire is flat or will not maintain air pressure.
	<ol style="list-style-type: none"> 1. Check for tire damage. If tire is damaged, contact an Authorized Segway Dealer to order a replacement Tire/Wheel Assembly. 2. If there is no visible tire damage, check to make sure tire valve stem core is tight. Tighten if necessary. 3. Inflate tire and check for leaks. If tire goes flat or will not maintain air pressure, contact an Authorized Segway Dealer to order a replacement Tire/Wheel Assembly.



The Segway HT tire is tubeless. The tire is not easily separated from the wheel. Do not attempt to separate the tire from the wheel to repair a flat tire. You could damage the tire and the wheel.

Problem	Safety Shutdown while entering or leaving a store, library, or other building.
<p>Theft detection systems may interfere with Segway HT operation. Many libraries, retail stores, and other buildings use theft detection systems to detect protected items as they enter and exit a building. These systems are usually situated at the building entrances and exits so that patrons must pass through on their way in and out. These systems may not always be visible. Some theft detection systems have caused the Segway HT (in Balance Mode) to perform a Safety Shutdown.</p> <ol style="list-style-type: none"> 1. Step off at least 5 feet (1.5 meters) away from theft detection systems and proceed through the theft detection system in Power Assist Mode or with the Segway HT powered off. 2. Once at least 5 feet (1.5 meters) away from the detectors, riders may return to Balance Mode and step on. 	

Problem	Pressing the Mode Button does not cause the Segway HT to power down or change into Power Assist mode.
<ol style="list-style-type: none"> 1. Check that your Mat is not sticking to the Platform (see page 41). If the Mat is sticking, lift the Mat to release it, while being careful to hold onto your Segway HT, and not move it forward or backward. 2. Replace the Mat on the Platform 3. Press or tap the Mode Button 4. If the Segway HT still will not power down or change into Power Assist Mode, contact an Authorized Segway Dealer to arrange for service. 	

Display Messages

The Display on the Handlebar indicates the following information:

- > The operational mode of the Segway HT (Power Assist Mode or Balance Mode)
- > The battery charge level
- > Whether a fault is detected in any system

It is important to understand all the icon messages that may appear in the Display.

Display Colors

Green (and only green) means you may step on and ride in Balance Mode. Orange indicates Power Assist Mode. Red means something is wrong.

If the Display is in direct sunlight, it may be difficult to see the color and the icon. Try shading the Display with your hand. If the Display is not illuminated, the Segway HT is not powered on.





Startup Error Conditions





If you attempt to power on your Segway HT, but the Segway HT detects a condition that precludes power on, one of the following icons will appear in the Display. You may clear these conditions with the user response described.



WARNING!

Do not attempt to step on the Segway HT until you have cleared the error condition and you have confirmed that the Segway HT is in Balance Mode.

Display Icon	Startup Error Conditions	User Response
 (red)	The Key being used to start the Segway HT does not contain the correct security code.	Restart using correct Key. If condition continues, contact an Authorized Segway Dealer.
 (red)	The Segway HT is plugged in.	Unplug the Power Cord and, if the Segway HT has powered off, power on again.
 (red)	The battery is too low to allow safe operation of the Segway HT.	Charge the Battery Packs; then attempt to power on.
 (red)	The Steering Grip is turned to the left at startup.	Be sure your hand is not turning the Steering Grip. Gently move the grip to ensure it is in the center (straight-ahead) position.
 (red)	The Steering Grip is turned to the right at startup.	

Display Icon	Startup Error Conditions (Continued)	User Response
 (red)	Right front rider detect sensor is on at startup.	Make sure your foot is not on the Platform when powering on. Check the Mat to ensure it is clear of foreign objects and not sticking to the Platform. If necessary, remove the Mat (see page 41) and inspect beneath it.
 (red)	Left front rider detect sensor is on at startup.	
 (red)	Left rear rider detect sensor is on at startup.	
 (red)	Right rear rider detect sensor is on at startup.	
 (red)	Mode Button is depressed at startup.	

Display Icon	Startup Error Conditions (Continued)	User Response
 (red)	Battery Packs installed on the Segway HT are different chemistry types, for example, one NiMH and one Li-ion.	Install two Battery Packs of the same chemistry type.





Error When Attempting to Enter Balance Mode

The following Display icon may appear when you attempt to enter Balance Mode.

Display Icon	Entering Balance Mode	User Response
 (red)	Platform not level when attempting to enter Balance Mode.	Level Platform, tap the Mode Button to enter Balance Mode.

Normal Operation

The following Display icons should appear each time you power on or power off your Segway HT.

Display Icon	Normal Operation	User Response
 (no backlight)	Startup test being performed. (All segments should be displayed, with no backlight.)	Wait before attempting to use the Segway HT.
 (orange)	Segway HT is in Power Assist Mode (full battery charge level shown).	Do NOT attempt to step on the Segway HT. It is not in Balance Mode. Rotate Steering Grip to move the Segway HT forward and back.
 (green)	Segway HT is in Balance Mode (full battery charge level shown).	You may step on and ride the Segway HT.
 (orange)	Segway HT is powering off. This icon should only appear when you power off. (Display segments vary depending on software version.)	Do not attempt to power on until backlight disappears. (In cold weather, it may take a few seconds for this icon to disappear.) Do not step onto the Segway HT.

Reduced Performance Levels

The following Display icon (the face is not smiling) will appear if the Segway HT is operating at reduced performance levels due to a temporary condition. See page 15 for a list of these conditions.

Display Icon	Reduced Performance	User Response
 (green)	The Segway HT is operating at reduced performance levels, with the speed limit lowered, due to a temporary condition.	Slow down! Stop leaning forward and slow down until the Handlebar stops pushing back and the Display returns to a green smiling face.

Critical Faults During Balance Mode

If, during normal riding, the Segway HT detects a fault in any of its redundant subsystems (see page 12), the Segway HT will perform a Safety Shutdown by automatically reducing its speed, shaking its Handlebar, making growling and beeping noises, and flashing red in the Display. The following Display icon will appear.

Display Icon	Critical Faults	User Response
 (red)	The system has detected a critical error, is slowing to zero speed, and is performing Safety Shutdown (full battery charge level shown).	Come to a controlled stop, then safely step off and discontinue operation. You have approximately 10 seconds from the start of Safety Shutdown to come to a controlled stop and safely step off before the Segway HT automatically shuts down.



Pitch or Roll Angle Exceeded



The following Display Icon will appear if the Segway HT shut down because a forward, backward or side tilt limit was exceeded, or no rider detect sensors were depressed while the Segway HT was moving at speed. The Segway HT is programmed to shut down in these situations because no rider is in control of the Segway HT.

Display Icon	Hazardous Condition	User Response
 (red)	The Segway HT shut down because a forward, backward, or side tilt limit was exceeded or no rider detect sensors were depressed while the Segway HT was moving at speed.	Check Segway HT for damage. If no damage, use Key to power on.

System Faults

If the Segway HT detects a fault in its hardware one of the following icons will appear in the Display. The Segway HT cannot be used until the fault is cleared.

Display Icon	System Faults	User Response
 (red)	There is a fault in the Platform.	<ol style="list-style-type: none"> 1. Check and make sure the two Control Shaft Cord connections are properly connected (see pages 38–39). 2. Power on the Segway HT. 3. If the same icon appears, confirm that the Battery Pack type is correct for your model see page 11).
 (red)	There is an unlocated fault in the Segway HT.	<ol style="list-style-type: none"> 4. If the same icon appears remove and reseal both Battery Packs (see pages 39–40). 5. Power on the Segway HT. If the same icon appears, contact an Authorized Segway Dealer.

Display Icon	System Faults	User Response
 (red)	There is a fault in the rear Battery Pack.	<ol style="list-style-type: none"> 1. Remove and reseal the faulted Battery Pack (see pages 39–40). 2. Power on the Segway HT. 3. If the same icon appears, remove both Battery Packs, reverse locations of the Battery Packs and reattach both Battery Packs.
 (red)	There is a fault in the front Battery Pack.	<ol style="list-style-type: none"> 4. If, after reattaching the Battery Packs, the same icon appears (indicating that the fault remains in the same Battery Pack location), make sure the two Control Shaft Cord connectors are properly connected see pages 38–39). Then, power on the Segway HT. If the same icon appears, contact an Authorized Segway Dealer. 5. If, after reattaching the Battery Packs, the icon changes to indicate that the fault is now in the other Battery Pack location, contact an Authorized Segway Dealer to order a new Battery Pack. Because the Segway HT performs at the level of the lesser Battery Pack, whenever you replace a Battery Pack consider replacing both Battery Packs, depending upon the age of the non-fault Battery Pack (see page 28).

chapter 5: service

General Information

If you have a question on parts or replacements, please contact an Authorized Segway Dealer. For a list of Dealers, visit www.segway.com.

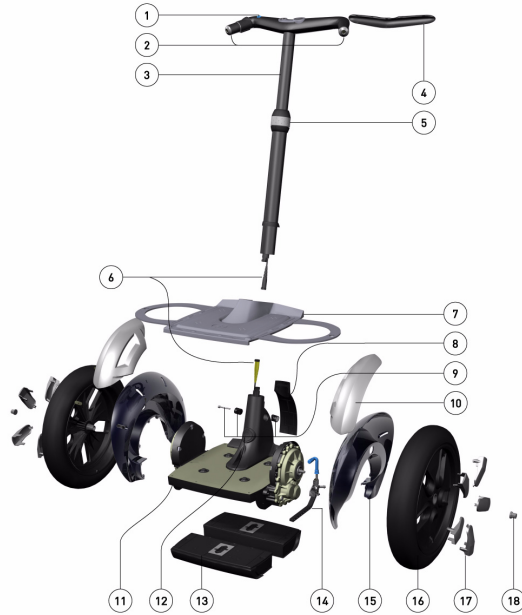

i180

Parts Diagram

(shown on the i180)

1. Mode Button
2. Steering Grip (L) and Fixed Grip (R)
3. Control Shaft
4. Handlebar Trim
5. Height Adjustment Collar
6. Control Shaft Cords
7. Mat
8. Front Trim
9. Control Shaft Clamp Bolt and Clamps (2)
10. Splashguard (2)
11. Platform with Control Shaft Base and Gearboxes
12. Charge Port Cover
13. Rechargeable Battery Packs (2)
14. Parking Stand (i Series only)
15. Fender (2)
16. Standard Tire/Wheel Assembly (2)
17. Wheel Inserts (5 per Wheel)
18. Wheel Nut (2)

(shown on the Segway XT)

19. All-terrain Tire/Wheel Assembly
20. Segway XT Fender (2)
21. Fender Frame with Lifting Handle (2)



Segway XT

Service Procedures

Follow these procedures when instructed to do so by the Troubleshooting section of this Reference Manual. The tools provided in the Wrench Set included with your Segway HT are intended to assist with these procedures. However, additional tools, such as a torque wrench may be necessary to perform some of these procedures correctly.

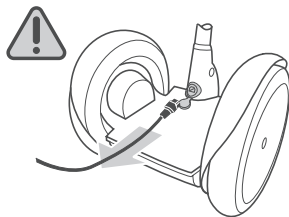

WARNING!

Always shut down your Segway HT and unplug the Power Cord before performing any maintenance or installing any part or accessory.

Remove Handlebar/Control Shaft Assembly

Tool required: 5 mm hex wrench.

1. Make sure the Segway HT is powered off and not plugged in. It is unsafe to perform this procedure while the Segway HT is powered on or charging.
2. Loosen the Height Adjustment Collar and collapse the upper portion of the Control Shaft fully into the lower portion of the Control Shaft.
3. Gently tighten the Height Adjustment Collar.
4. Using the 5 mm hex wrench, loosen (but do not remove) the Control Shaft Clamp Bolt.
5. Lift the Handlebar/Control Shaft Assembly up and out of the Control Shaft Base far enough to expose the two Control Shaft Cord connections.
6. Separate the Control Shaft Cords at the connections by depressing the tabs and gently pulling the Control Shaft Cords apart.

Replacing Parts

If a part breaks or needs replacement, contact an Authorized Segway Dealer. For a list of Dealers, visit www.segway.com. Certain parts are owner-replaceable. Use only Segway-provided replacement parts and fasteners.

Torque Specifications

Adhere to torque specifications when tightening fasteners. Over-tightening or under-tightening fasteners can result in machine damage or malfunction

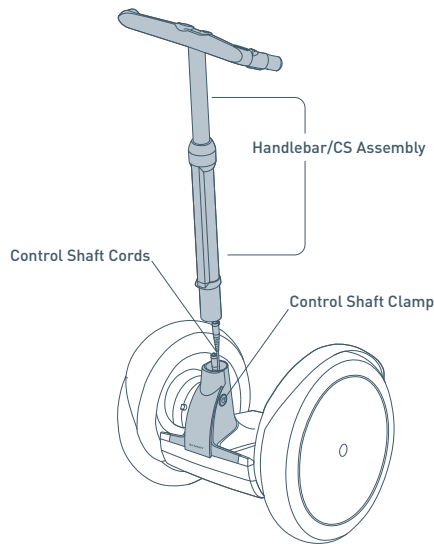

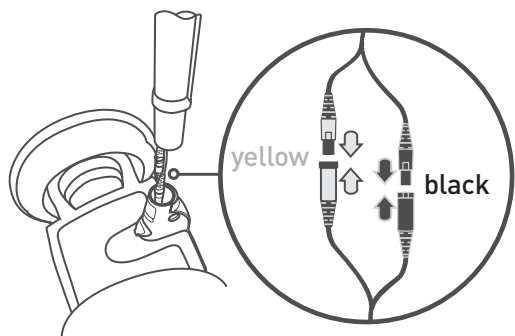

Install Handlebar/Control Shaft Assembly

Tool required: 5 mm hex wrench.

1. Make sure the Segway HT is powered off and not plugged in. It is unsafe to perform this procedure while the Segway HT is powered on or charging.
2. Loosen the Height Adjustment Collar and slide the upper part of the Handlebar/Control Shaft Assembly fully into the lower part of the Control Shaft. Gently tighten the Height Adjustment Collar.
3. Reach into the Control Shaft and pull down the tag to access the Control Shaft Cords. Connect these two Control Shaft Cords from the Control Shaft to the Control Shaft Base. Connect black to black, and yellow to yellow. Make sure prongs are properly aligned and snapped into place. The connection of the black Control Shaft Cords produces a tone.

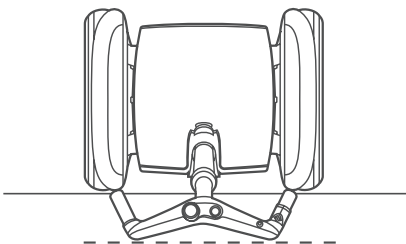

4. Loosen the Height Adjustment Collar and extend the Handlebar/Control Shaft Assembly approximately 6 inches (15 cm). Then, tighten the Height Adjustment Collar.
5. Insert the bottom of the Handlebar/Control Shaft Assembly into the opening in the base. Push the Handlebar/Control Shaft Assembly all the way in so that the rubber O-ring near the bottom contacts the base. Be careful not to pinch the cords.
6. Lay the Segway HT down forward onto the Handlebar to properly align the Handlebar parallel with the front of the base.
7. Securely tighten the Control Shaft Clamp Bolt using the 5 mm hex wrench.

Tightening Torque: 6.8 N-m (5.0 ft-lbf)

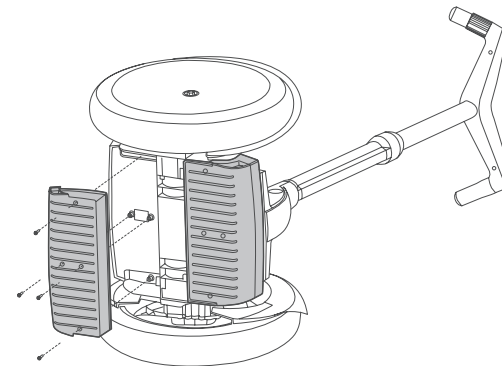

Remove the Battery Packs

Tool Required: 3 mm hex wrench.

1. Make sure the Segway HT is powered off and not plugged in. It is unsafe to perform this procedure while the Segway HT is powered on or charging.
2. Tip the Segway HT onto its side so that the outside of one of the wheels lays flat against a clean, smooth surface. (Lay the p Series machine forward, rather than on its side, for this procedure, to avoid damage to the wheel.)
3. Use the 3 mm hex wrench to remove the fasteners (4 per Battery Pack).
4. Pull Battery Packs straight off chassis.

Reseat the Battery Packs

Tool Required: 3 mm hex wrench.

1. Make sure the Segway HT is powered off and not plugged in. It is unsafe to perform this procedure while the Segway HT is powered on or charging.
2. Reseat Battery Packs on chassis with curved edge facing outside of chassis.
3. Thread in the fasteners and tighten with the 3 mm hex wrench (4 per Battery Pack). **To avoid risk of damage, do not use a power tool to thread in or tighten fasteners.**

Tightening Torque: 1.0 N-m (8.9 in-lbf)



WARNING!

The cells within the Battery Packs contain toxic substances. Do not attempt to open Battery Packs. Do not use the Battery Pack if its casing is broken or if it emits an unusual odor or excessive heat or leaks any substance. Do not handle a damaged or leaking Battery Pack unless you are wearing disposable rubber gloves, eye protection, and are in a well-ventilated area. Dispose of rubber gloves and damaged Battery Pack properly in accordance with regulations governing disposal of toxic materials.

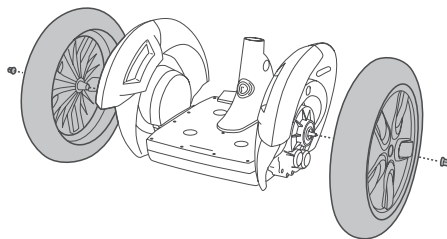

Remove Tire/Wheel Assembly

Tools Required: 16 mm deep socket wrench with 8" (20 cm) or longer wrench handle, rubber mallet, for the Segway XT you will also need a minimum 3" (75 mm) socket extension/extension bar.

1. Make sure the Segway HT is powered off and not plugged in. It is unsafe to perform this procedure while the Segway HT is powered on or charging.
2. Tip the Segway HT onto its side so that the outside of one wheel lays flat against a clean, smooth surface. (The p Series wheel is dome-shaped and will not lay flat. Make sure to protect the Wheel from damage by placing it on a thick, soft surface.)
3. Remove the Wheel Nut with a 16 mm deep socket wrench. Hold the wheel from rotating and turn the wrench counterclockwise. (This may require considerable force.)
4. Strike the outside edge of the tire with a rubber mallet to unseat the wheel hub taper. (This may

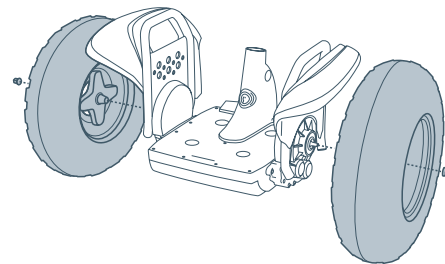

require multiple attempts as the wheel hub is seated tightly into the Gearbox taper.)

5. Lift off the wheel.
6. Clean any debris from outside of drive shaft and inside of wheel hub.

Reseat Tire/Wheel Assembly

Tools Required: 16 mm deep socket wrench with 8" (20 cm) or longer wrench handle, for the Segway XT you will also need a minimum 3" (75 mm) socket extension/extension bar.

1. Make sure the Segway HT is powered off and not plugged in. It is unsafe to perform this procedure while the Segway HT is powered on or charging.
2. Place the wheel hub opening over the Gearbox drive shaft; rotate the wheel while pressing down until the wheel seats.
3. Thread on the wheel nut and tighten with the socket wrench.

Tightening Torque: 50.0 N-m (36.9 ft-lbf)

Remove/Reinstall Mat

Tools Required: None for p Series or Segway XT models. For i Series or Segway GT models, if you have any Gearbox-mounted part installed, you must first remove that part, prior to removing the Mat.

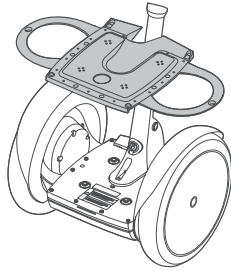

1. Make sure the Segway HT is powered off and not plugged in. It is unsafe to perform this procedure while the Segway HT is powered on or charging.
2. Lift Mat off Platform. For i Series and Segway GT models, pull both “ears” of the Mat inward, out of fender channels.

Reinstall Mat

Tool Required: None.

1. Make sure the Segway HT is powered off and not plugged in. It is unsafe to perform this procedure while the Segway HT is powered on or charging.
2. Before installing Mat, make sure top of Platform and bottom of Mat are clean, dry, and free of debris.
3. Place new Mat on Platform and press down.
4. For i Series and Segway GT models, press ears back into the fender channels, then reinstall any Gearbox-mounted part, following the instructions that came with that part.

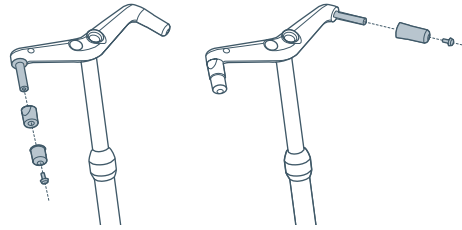

Remove Grips

Tool required: 5 mm hex wrench.

1. Make sure the Segway HT is powered off and not plugged in. It is unsafe to perform this procedure while the Segway HT is powered on or charging.
2. Remove grip by removing the bolt using the 5 mm hex wrench.
3. Pull grip off shaft.

Reinstall Grips

Tool required: 5 mm hex wrench.

1. Make sure the Segway HT is powered off and not plugged in. It is unsafe to perform this procedure while the Segway HT is powered on or charging.
2. Before installing grip, make sure inside of grip and outside of shaft are clean, dry, and free of debris.
3. Slide grip onto shaft. Note that it is keyed and will only go on one way.
4. Thread in fastener and tighten with 5 mm hex wrench.

Tightening Torque: 6.8 N-m (5.0 ft-lbf)

Cleaning

Clean your Segway HT with soap and water and a soft cloth. Do not use a power washer or high pressure hose because this could drive water into components that must stay dry. Avoid getting water in the Charge Port.



WARNING!

Never clean the Mat or tires with any specialized cleaners because these products may reduce traction, resulting in injury.

Do Not Open the Platform or Gearboxes

Do not attempt to open the Platform. There are no user serviceable parts inside. By opening the Platform, you risk electric shock injury. Also, you could void your limited warranty, damage your Segway HT, and render it unsafe to use. Do not attempt to open the Gearboxes. There are no user serviceable parts inside. You could damage your Segway HT and render it unsafe to use.

Accessories

You may be interested in adding accessories to your Segway HT. Please contact an Authorized Segway Dealer or visit www.segway.com to learn what accessories are available. For a list of Dealers, visit www.segway.com.

chapter 6: frequently asked questions

Please visit our website, www.segway.com, for a complete list of up-to-date frequently asked questions and answers.

Can the Segway HT climb stairs?

You should not attempt to ride the Segway HT up or down stairs. Use Power Assist Mode as described in the Riders' Guide and the Safety Video.

How often should I check the air pressure in the tires on the Segway HT?

Check tire inflation pressure regularly, at least monthly (see page 19). The air pressure in the tires should be set at the pressure stated on the wheel label near the inflation valve (not the pressure stated on the tire sidewall).

What type of maintenance does the Segway HT require?

The Segway HT requires very little maintenance. Check your tire inflation pressure regularly, at least monthly (see page 19). Charge your Batteries as described in this manual (see page 24). Check to make sure your Segway HT has no loose parts. Gently clean with soap and water. Gearboxes require no maintenance and are sealed. No component of the Segway HT requires lubrication.

How do I get a replacement Key?

Make a note of your Key Code and Segway HT Serial Number (see page 4). Contact Segway Customer Operations at 1-866-4SEGWAY (1-866-473-4929) to order replacement Keys.

What can I use to clean my Segway HT?

Use soap and water. See page 41. Please refrain from using products which protect and shine rubber, plastic, and vinyl surfaces, as these products may impact tires traction. Avoid getting water in the Charge Port. See "Avoid Submersion" on page 20.

How should I dispose of my old batteries?

Segway encourages you to help preserve our environment by properly disposing of your Segway HT Battery Packs. Refer to specific instructions on your Battery Warning Label, or check with an Authorized Segway Dealer to find the nearest location. For a list of Dealers, visit www.segway.com.

What is the noise my Segway HT makes while I'm just standing still?

Just like you hear a fluorescent light buzzing, the effect of the electricity moving through the Segway HT parts (circuit boards, motors) results in the sound you hear.

Can I charge my Segway HT in countries where the power is at different voltages?

Yes, as long as the voltage is between 100 and 240 V, and 50 to 60 Hz AC (this covers most of the Americas, Europe and Asia). You might need an adapter at the end of the Power Cord that goes into the wall outlet. Alternatively, you can use a standard International Electrotechnical Commission (IEC) cord (typically used for computers and monitors) designed your location. The adapters and IEC cables can be found at most electronic stores.

Are there accessories available for my Segway HT such as bags, locks, lights, horns, and reflectors?

Yes, there are many accessories available. Please visit www.segway.com or contact an Authorized Segway Dealer. For a list of Dealers, visit www.segway.com.

chapter 7: contact and legal information

Report All Incidents

If you or any other user of your Segway HT is involved in an accident, or if your Segway HT performs in a way that you do not intend or in a way that it is not supposed to, contact Segway Customer Operations by telephone at 1-866 4SEGWAY (1-866-4929), or by Email: technicalsupport@segway.com

How to Reach Us

Call Segway in the USA (English-language only) at +1-866-473-4929.

Email Segway directly (English-language only) at technicalsupport@segway.com.

An Authorized Segway Dealer can answer your questions about your Segway HT via the web, email, or phone. For a list of Dealers, visit www.segway.com.

California Warning

This product contains chemicals, including lead, known to the State of California to cause cancer, birth defects or other reproductive harm.

Obey All Laws and Regulations

Many governmental authorities regulate use of Segway HTs on public roads and sidewalks. In addition to other requirements, these laws and regulations may prescribe minimum ages for Segway HT riders and may set speed limits and mandate protective gear for riders. Some governmental authorities prohibit use of Segway HTs on public roads and sidewalks. You should consult local authorities to become familiar with applicable laws and regulations. (In the USA, many of these laws use the term “Electric Personal Assistive Mobility Device” or “Personal Motorized Mobility Device,” which are specifically defined to include Segway HTs.)

Segway Human Transporter Limited Warranty

Segway LLC provides with each Segway HT a “Segway® Human Transporter Limited Warranty.” This is the only warranty applicable to the Segway HT. Consult the “Segway® Human Transporter Limited Warranty” delivered with your Segway HT for the specific terms of limited warranty coverage.

UNITED STATES FCC PART 15 CLASS B RADIO FREQUENCY INTERFERENCE (RFI)

The Segway HT has been tested and found to comply with the limits for Class B digital devices pursuant to Part 15, Subpart B of the Rules. These limits are designed to provide reasonable protection against harmful interference in a residential environment. The Segway HT generates, uses, and can radiate radio frequency energy, and, if not installed and used in accordance with the User Materials, may cause harmful interference to radio communications. However, there is no guarantee that interference will not occur in a particular installation.

If the Segway HT does cause harmful interference to radio or television reception, which can be determined by turning the Segway HT off and on, the user is encouraged to try and correct the interference by one or more of the following measures:

- > Reorient or relocate the receiving antenna.
- > Increase the distance between the Segway HT and the receiver.
- > Connect the Segway HT into an outlet on a circuit different from that to which the receiver is connected.
- > Consult the dealer or an experienced radio/TV technician for help.

- > This device complies with Part 15 of the FCC Rules. Operation is subject to the following two conditions:
- > This device may not cause harmful interference.
- > This device must accept any interference received, including interference that may cause undesired operation.

Changes or modifications to this equipment not expressly approved by Segway may void the user's authority to operate this equipment.

Canadian ICES-003

The Segway HT is a Class B digital apparatus that complies with Canadian ICES-003.

European Directives

The Segway HT complies with the requirements of European Directives 89/336/EEC, Directive of Electromagnetic Compatibility; 73/23/EEC, Low Voltage Directive; and 98/37/EC, Machinery Directive.

Other Standards

The Segway HT also complies under the following: Applicable sections of Safety for Information Technology Equipment, IEC950, CAN/CSA C22.2 No. 60950-00, UL 60950. Applicable sections of UL Standard for Safety for Motor-Operated Appliances, UL73. Applicable sections of Motor-Operated Appliances (Household and Commercial), CAN/CSA-C22.2 No. 68-92. Degrees of Protection Provided by Enclosures (IP code), IEC 529.

Segway LLC Trademarks

Segway LLC owns a number of trademarks used in this manual, including Segway® and the Segway Flyer symbol. Failure of a mark to appear in this manual does not mean Segway LLC does not use the mark, nor does it mean that the product is not actively marketed or is not significant within its relevant market.

Patent and Licensing Information

The Segway HT is covered by US and foreign patents, including one or more of the following:

US Patent numbers (issued): 5,701,965; 5,791,425; 5,794,730; 5,971,091; 5,975,225; 6,223,104; 6,288,505; 6,302,230; 6,332,103; 6,357,544; 6,367,817; 6,405,816; 6,408,240; 6,415,879; 6,435,535; 6,443,250; 6,538,411; 6,543,564; 6,553,271; 6,561,294; 6,571,892; 6,575,539; 6,581,714; 6,598,941; 6,651,763; 6,651,766; 6,715,845; 6,779,621; 6,789,640; 6,796,396; 6,799,649; 6,815,929; 6,827,163; D489,027; D489,029; D489,300; D493,127; D493,128; D493,129; D493,392; D493,749.

US Patent Pending (published application serial numbers): 20020063006; 20020149172; 20030146025; 20030183435; 20030226698; 20030231022; 20040005958; 20040007399; 20040011573; 20040050611; 20040055795; 20040055796; 20040055804; 20040069543; 20040118622; 20040129464; 20040183272; 20050017733.

Foreign Patent numbers (issued): AU: 705704; 726250; 726253; 727183; 728453; 729781; 738013. CA: 2211738. KR: 346992; 351082; 363809. MX: 205144. NZ: 282114; 330431. RU: 2153868. TW: 129673; 130073; 154350; 157146; 159151; 171,217.

Foreign Patent Pending (published application serial number): AT: 95911624.5. AU: 62669/99; 21703/00; 37202/00; 37430/00; 37450/00; 33980/00; 54557/00; 53137/00; 80362/00. BE: 95911624.5. CA: 2,211,738; 2,346,442; 2,337,130; 2,363,737; 2,367,501; 2,375,313; 2,366,076; 2,373,275; 2,375,645; 2,382,360; 2,393,418; 2,401,488; 2,431,070. CH: 95911624.5. CN: 95197546.3; 00812269.5; 95197546.3. DE: 95911624.5; 00916035.9. DK: 95911624.5. ES: 95911624.5. EP: 1123235; 1159686; 1161214; 1161215; 1161216; 1180996; 1181187; 1183163; 1208032; 1237779; 1259415; 1298041; 1324911. FI: 973197. FR: 95911624.5; 00916035.9. GB: 95911624.5; 00916035.9. GR: 95911624.5. HK: 02101085.2; 02106106.6; 02106105.7; 03105015.7; 02106266.2; 02108322.0. ID: W00200102875; W00200102136; W00200102823; W00200200009; W00200200024; W00200200451; W00200201309. IE: 95911624.5. IL: 155,390. IN: IN/PCT/02/00280/CHE. IT: 95911624.5. JP: 8-523486; 2000-577062; 2001-508659; 2000-602941; 2000-604799; 2000-621191; 2000-604801; 2001-501161; 2001-501493; 2001-519543; 2001-543388; 2001-563370; 2003-35305. KR: 10-2001-7016896; 10-2001-7011189; 10-2001-7015260; 10-2001-7015490; 10-2001-7015564; 10-2002-7002673;

10-2002-7007338. MC: 95911624.5. MX: 2001/004018; PA/a/2001/012685; PA/a/2001/008933; PA/a/2001/009342; PA/a/2001/012232; PA/a/2001/009374; PA/a/2000/12498; PA/a/2001/012557; PA/a/2002/002217; PA/a/2002/005801; 000162. MY: PI20000540; PI20001210; PI200010118; PI20001458; PI20002479; PI20002502; PI200014753. NL: 95911624.5. NO: P973,153; 20011809. NZ: 513868; 517412; 525279. RU: 2000114547; 2002108569. SE: 95911624.5. SG: 200201245-8; 200203390-0. TW: 88117468; 89,106,673; 89,110,752. WO: 00/23315; 00/52588; 00/54719; 00/54720; 00/54721; 00/61426; 00/73101; 00/74623; 00/75001; 01/02920; 01/064502; /01/15962; 01/42077; 02/030730; 02/068219; 2003/103559; 03/105967; 2003/106250; 2004/007233; 2004/007264; 2004/075804; 2004/078603; 2005/009828.

Additional unpublished patent applications are pending.

Segway LLC manufactures and sells Segway HTs under a license from DEKA Products Limited Partnership.

index

A

AC power, 24
accessories, 41
adapters, 42
All-terrain Tire/Wheel Assembly, 8, 37
angular rate sensors, 14
assembly instructions, 2
authorized Segway dealer, 2

B

Balance Mode, 18, 29, 32, 34
 error while attempting to enter, 33
 problem entering, 33
Balance Sensor Assembly, 12, 13, 14
Battery Packs, 6, 12, 14, 36, 37
 battery maintenance stage, 25
 casing, 22
 cell balancing, 25
 charge level display, 24, 32
 charging, 10, 15, 24, 25
 discharge, 20
 disposal, recycle, 42
 electric shock, 22

fast charge, 25
fully charged, 25
ground clearance, 8
initial test, 25
interchangeable (front and back), 14
Li-ion, 7, 8, 11, 14, 22, 23, 25, 28
maximize battery life and performance, 22, 24
NiMH, 7, 8, 11, 14, 23, 24, 25, 28
permanent damage, 24
range, 7
remove and reseal, 39, 40
replacing, 28
safety guidelines, 22
shipping requirements, 22
specifications, 23
storage, 24
temperature parameters, 27
too cold, 26
too hot, 15, 26
toxic substances, 22
useful life, 28
bumpy terrain, 15

C

cell balancing, 25
center of gravity, 12
changing modes
 Balance Mode, 18
 Power Assist, 18
 Power Off, 18
charge level display, 26, 27
Charge Port, 6, 24
Charge Port Cover, 37
charging Li-ion Battery Packs, 25
charging NiMH Battery Packs, 25
charging process, 25
cleaning, 41, 42
contact information, Segway, 3
Control Shaft, 6, 37
 clamp bolt, 6, 37
 clamps, 37
 cords, 13, 14, 37
Control Shaft Base, 37
Controller Boards, 12, 13

D

Display, 6, 32
display messages, 32

- battery charge level, 32
- critical error, 17, 35
- inadequate battery charge, 26
- operational mode, 32
- reduced performance, 15, 28, 34

disposal of Battery Packs, 42
dynamic stabilization, 12

E

electric shock, 22, 41
Email, 3
enhanced traction tires, 8

F

Fender, 6, 37
Fender Frame, 37
Fixed Grip, 6, 37
foot pressure, 9, 15
foreign patent numbers, 44
Front Trim, 6, 37

G

Gearboxes, 37
grips, 41

- installing and removing, 41
- steering, 14

ground clearance, 8
growling noise, 16, 17, 35
gyroscopes, 13

H

Handlebar, 6

- beeping, 17
- cargo, 7, 9
- electronics, 12, 14
- shaking, 17, 35

Handlebar Trim, 37
Handlebar/Control Shaft Assembly

- troubleshooting, 29

Height Adjustment Collar, 6, 37
higher payloads, and relation to weight limits, 9
higher speeds, and relation to weight limits, 9
horsepower, 13
how the Segway HT works, 12
humidity, 20

I

i Series, 11

- i180, 6
 - specifications, 7
- i180, 37

IEC cables, 42
initial test, 25
international usage, 42

K

Keys

- Key Port, 6
- replacing, 4

L

lateral stability, 12
laws and regulations, 43
LEDs, 25
lifting and loading your Segway HT, 20
Lifting Handles, 20, 37
lithium-ion (Li-ion) Battery Packs, 7, 8, 11, 14, 22, 23, 25, 28

- recalibrating battery charge level display, 27

M

Mat, 37
 maximum handlebar cargo weight, 7, 9
 maximum payload (rider plus all cargo), 7
 maximum speed, 7
 minimum rider weight, 7
 minimum weight limit, 9
 mixed battery types, 14, 28
 Mode Button, 6, 14, 18, 37
 Motors, 12, 13

N

nickel metal hydride (NiMH) Battery Packs, 7, 8,
 11, 14, 23, 24, 25, 28
 charging process, 25
 i Series (60-cell), 23
 limit discharge, 24
 p Series (48-cell), 23
 noise
 beeping, 17, 35
 growling, 16, 17, 35
 note icon, 4

O

operating temperature, 23
 operational mode
 Balance Mode, 32
 Power Assist, 32

P

p Series, 6, 11
 specifications, 7
 Parking Stand, 6, 21, 37
 retract or deploy, 21
 patent and licensing information, 44
 payload, 7
 pitch, roll and yaw, 14
 Platform, 6, 36, 37
 height, 8
 stepping on while in Power Assist Mode, 16
 pollution emissions, 13
 Power Assist Mode, 18, 34, 42
 power off, 34
 power requirements, 7
 power washer, 41
 pulse rates, LEDs during charging, 25

R

Radio Frequency Interference (RFI), 43
 range, 7, 19
 range on a full charge, 7
 rapid charge depletion, 27
 rechargeable Battery Packs, 7, 28, 37
 red charging indicator, 26
 red unhappy face, 17, 26
 reduced performance levels, 34
 redundant subsystems, 12, 17
 Balance Sensor Assembly, 12
 Battery Packs, 12
 Controller Boards, 12
 Handlebar electronics, 12
 Motors, 12
 regenerative braking, 15, 27
 relative charge level, 27
 replacement keys, 4, 42
 replacing
 Battery Packs, 28
 parts, 37
 Rider Detect Sensors, 18
 rider weight, 7
 Riders' Guide, 3

S

Safety Shutdown, 13, 14, 17, 28, 35
Safety Video, 3
security, 19
Segway Customer Operations, 3
Segway GT, 6, 7, 11
 specifications, 7
Segway XT, 6, 7, 11, 37
 Fender and Lifting Handle, 37
 specifications, 7
serial number and key code, 4
service procedures, 38
shipping requirements, Li-ion Battery Packs, 22
solid state gyroscopes, 14
specifications
 Battery Pack, 23
 Segway HT models, 7
Speed Limiter, 15
Splashguard, 6, 37
stairs, use on, 42
standards, 44
 Canadian ICES-003, 44
 European directives, 44
 other, 44
startup error conditions, 32
 inadequate battery charge, 32
 incorrect key, 32
 mode button depressed, 33

plugged in, 32

 rider detect sensor depressed, 33

startup test, 34

Steering Grip, 6, 14, 37

 pulls to left or right, 30

Stick Shake Warning, 16, 18

storage, 20

structural weight limits, 9

surface charge, 27

suspension, 19

system faults, 36

T

tilt sensors, 14

tire inflation pressure, 7, 19, 42

Tire/Wheel Assembly, 6, 19

 all-terrain, 37

 remove and reseal, 40

 standard, 37

torque specifications, 38

towing, 21

traction, 19, 41

trademarks, 44

transporting your Segway HT, 22

trim, front and handlebar, 37

troubleshooting, 4, 38

turning radius, 7

U

unequal tire pressure, 19

US patent numbers, 44

user serviceable parts, 41

V

voltage, 24, 42

W

warning icon, 4

warranty, 43

website, 2

Wheel Inserts, 20, 37

Wheel Nut, 19, 37

wheel wobble, 19

X, Y, Z

yaw, 14

notes

enjoy the ride



fun, smart transportation

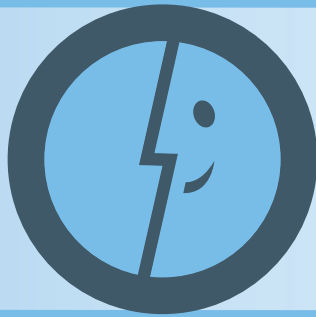

www.segway.com

1891600000ag