

SEGWAY miniLITE

USER MANUAL



The manufacturer reserves the right to make changes to the vehicle, release firmware updates, and update this manual at any time. Visit www.segway.com to download the latest user materials and watch the safety video. You must install the App to follow the New Rider Tutorial, activate your miniLITE, and obtain the latest updates and safety instructions.

Go to www.segway.com to watch the safety video.
Visite www.segway.com para baixar o manual do usuário.

Contents

1 Riding Safety	01
2 Packing List	03
3 Diagram	04
4 Assembling Your miniLITE	05
5 Charging	05
6 First Ride	06
7 Learning to Ride	07
8 Warning	09
9 Features	12
10 Maintenance	13
11 Specifications	14
12 Certifications	15
13 Trademark and Legal Statement	17
14 Contact	18

Thanks for choosing the miniLITE!

Thanks for choosing the Segway miniLITE (hereinafter referred to as miniLITE).

Enjoy the many features of your miniLITE. Your miniLITE is easy and safe to control. Have fun with it!

Enjoy your ride!

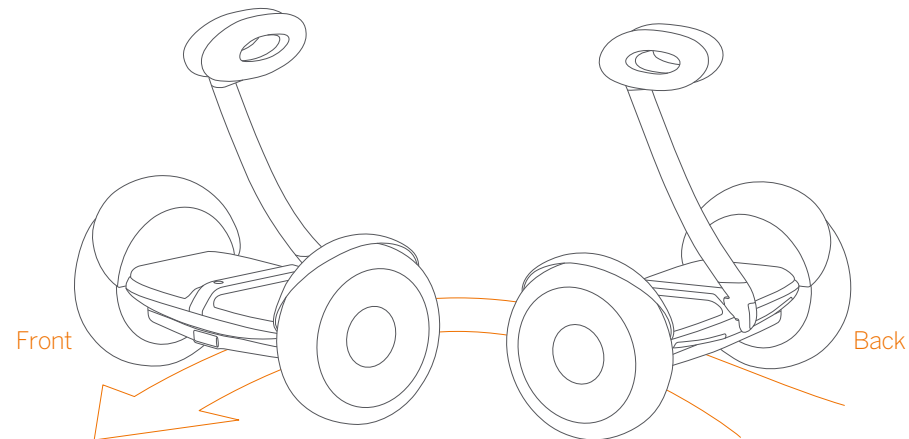

▲ WARNING

Always step on/off from the back of the miniLITE.
Otherwise you risk falls and/or collisions because the steering direction is reversed.

1 Riding Safety

1. The miniLITE is a recreational product. Before mastering riding skills, you need to practice. Neither Ninebot (means Ninebot (Beijing) Tech Co., Ltd. and its subsidiaries and affiliates) nor Segway Inc. is responsible for any injuries or damage caused by a rider's inexperience or failure to follow the instructions in this document.
2. Please understand that you can reduce the risk by following all the instructions and warnings in this manual, but you cannot eliminate all the risks. Remember that whenever you ride the miniLITE you risk injury or death from loss of control, collisions, and falls. When entering into public spaces always comply with the local laws and regulations. As with other vehicles, faster speeds require longer braking distance. Sudden braking on smooth surfaces could lead to wheel slip, loss of balance, or falls. Be cautious and always keep a safe distance between you and other people or vehicles when riding. Be alert and slow down when entering unfamiliar areas.
3. Always wear a helmet when riding. Use an approved bicycle or skateboard helmet that fits properly with the chin strap in place, and provides protection for the back of your head.
4. Do not attempt your first ride in any area where you might encounter children, pedestrians, pets, vehicles, bicycles, or other obstacles and potential hazards.
5. Respect pedestrians by always yielding the right of way. Pass on the left whenever possible. When approaching a pedestrian from the front, stay to the right and slow down. Avoid startling pedestrians. When approaching from behind, announce yourself and slow down to walking speed when passing. Please obey local traffic laws and regulations if situation is different.
6. In places without laws and regulations governing self-balancing electric vehicles, comply with the safety guidelines outlined in this manual. Neither Ninebot nor Segway Inc. is responsible for any property damage, personal injury/death, accidents, or legal disputes caused by violations of the safety instructions.
7. Do not allow anyone to ride your miniLITE on his/her own unless they have carefully read this manual, watched the safety video, and followed the New Rider Tutorial on the Ninebot by Segway App. The safety of new riders is your responsibility. Assist new riders until they are comfortable with the basic operation of the miniLITE. Make sure each new rider wears a helmet and other protective gear.
8. Before each ride check for loose fasteners, damaged components, and low tire pressure. If the miniLITE makes abnormal sounds or signals an alarm, immediately stop riding. Diagnose your miniLITE via the Ninebot by Segway App and call your dealer/distributor for service.
9. Be alert! Scan both far ahead and in front of your miniLITE — your eyes are your best tool for safely avoiding obstacles and low traction surfaces (including, but not limited to, wet ground, loose sand, loose gravel, and ice).
10. To reduce risk of injury, you must read and follow all "CAUTION" and "WARNING" notices in this document. Do not ride at an unsafe speed. Under no circumstance should you ride on roads with motor vehicles. The manufacturer recommends riders be 6+ years old. Always follow these safety instructions:
 - A. People who should not ride the miniLITE include:
 - i. Anyone under the influence of alcohol or drugs.
 - ii. Anyone who suffers from disease that puts them at risk if they engage in strenuous physical activity.
 - iii. Anyone who has problems with balance or with motor skills that would interfere with their ability to maintain balance.
 - iv. Anyone whose height or weight is outside the stated limits (see Specifications).
 - v. Pregnant women.
 - B. Riders under the age of 16 years old should ride under adult supervision.
 - C. Comply with local laws and regulations when riding this product. Do not ride where prohibited by local laws.
 - D. To ride safely, you must be able to clearly see what is in front of you and you must be clearly visible to others.
 - E. Do not ride in the snow, in the rain, or on roads which are wet, muddy, icy, or that are slippery for any reason. Do not ride over obstacles (sand, loose gravel, or sticks). Doing so could result in a loss of balance or traction and could cause a fall.
 - F. Do not accelerate or decelerate suddenly. Do not accelerate when the miniLITE tilts back or sounds an alarm. Do not attempt to override the speed limiter.
11. Do not attempt to charge your miniLITE if it, the charger, or the power outlet is wet.
12. As with any electronic device, use a surge protector when charging to help protect your miniLITE from damage due to power surges and voltage spikes. Only use the Segway supplied charger. Do not use a charger from any other product.
13. Use only Ninebot or Segway approved parts and accessories. Do not modify your miniLITE. Modifications to your miniLITE could interfere with the operation of the miniLITE, could result in serious injury and/or damage, and could void the Limited Warranty.
14. Do not sit on the steering bar. Doing so could result in serious injury and/or damage to your miniLITE.

2 Packing List

Steering Bar

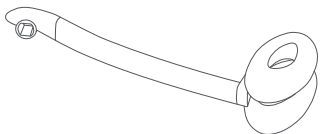

Mainframe

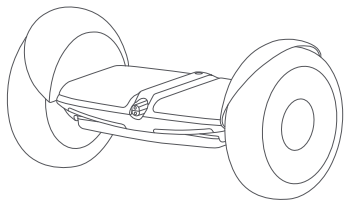

User Materials



Accessories Box



Accessories in the Box



Charger, Power Cord

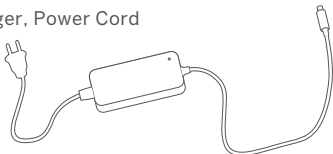

When unpacking your miniLITE, please verify that the above items are included in the package. If you are missing any components, please contact your dealer/distributor or nearest service center (see Contacts in the user manual). After verifying that all components are present and in good condition, you can assemble your new miniLITE.

Please retain the box and packaging materials in case you need to ship your miniLITE in the future.

Always power off your miniLITE and unplug the charge cable before assembling, mounting accessories, or cleaning.

3 Diagram

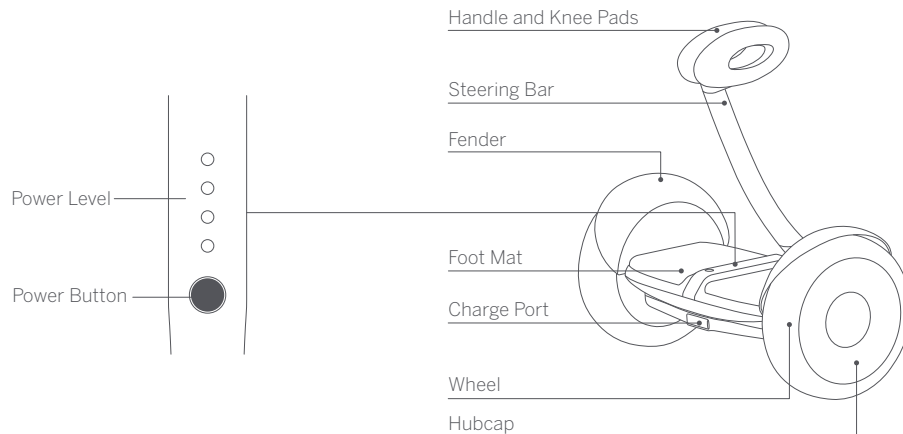

Power Button

Turn ON/OFF. The miniLITE will automatically power OFF when idle for 10 minutes, or when laid down (horizontal) for over 30 seconds.

Power Level

Indicates the remaining battery power. Each dot represents approximately 25% of the battery's power. When half of a dot's power has been consumed, that dot blinks. When the battery is nearly empty, the last dot blinks.

The miniLITE will gradually reduce the max speed limit as the power level gradually decreases. Use the App to view the remaining power and estimated remaining range.

4 Assembling Your Segway miniLITE

1. Slide the steering bar onto to the mounting bracket.
2. Install the two M5 screws. Tighten securely with the included hex wrench.
3. Press the rubber cap onto the steering bar until it snaps in place.

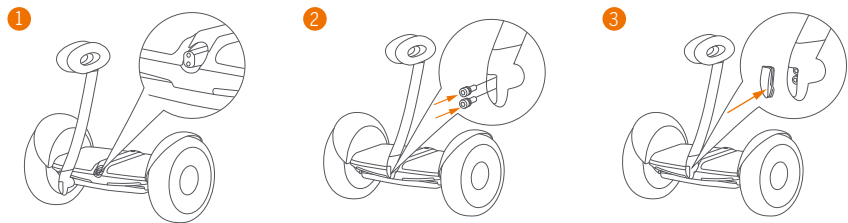

5 Charging

▲ Do not connect the charger if the charge port or charge cable is wet. The battery pack is only to be charged by adults.

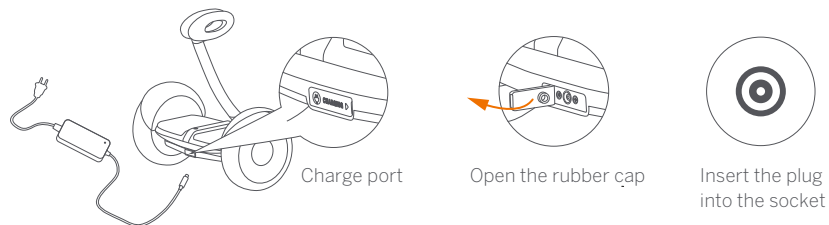

Your miniLITE is fully charged when the LED on the charger changes from red (charging) to green (trickle charge). Close the rubber cap when not charging.

6 First Ride ▲ There are safety risks when learning to ride the miniLITE. You must read the Safety Instructions and follow the New Rider Tutorial in the App before your first ride.



For your safety, your miniLITE is not activated at this time and will beep occasionally after Power ON.

Until activated, the miniLITE maintains a very low riding speed and steering sensitivity, and should not be ridden. Install the App on your mobile device (with Bluetooth 4.0 or above), connect to the miniLITE with Bluetooth, and follow the App instructions to activate your miniLITE and follow the training procedures.

Scan the QR code to download the App (iOS 8.0 or above, Android™ 4.3 or above).



1 Install the App and register/login.

2 Power ON the miniLITE.

3 Click "Vehicle" → "Search device" to connect. Your miniLITE will beep once when the bluetooth connection is successful.

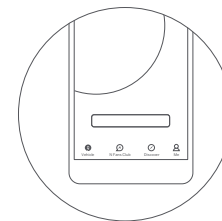

7 Learning to Ride

⚠ WARNING

Rider must weigh 22–176lbs (10–80 kg) and must be 3'7"–5'11" (110–180 cm) tall.

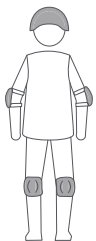

Wear an approved helmet and other protective gear to minimize any possible injury.

After activation, the App will lead you through the New Rider Tutorial. Please follow the instructions in the App and in this manual.

NOTE

You must first download the App on your mobile device. The App will lead you through the New Rider Tutorial.

For your safety, the miniLITE will limit the max speed to 2.5 mph (4 km/h) until you complete the New Rider Tutorial. For the first 0.6 miles (1 km) after completing the New Rider Tutorial, the max speed will be limited to 6.2 mph (10 km/h), after which you can disable the speed limiter via the App and reach a maximum speed of 10 mph (16 km/h).

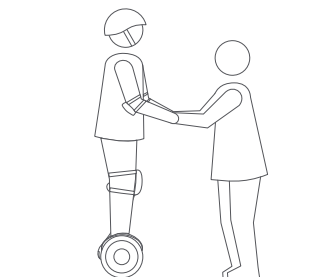
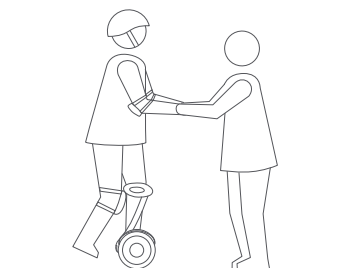

- 3 Slowly transfer your weight onto the miniLITE. The unit will beep, indicating it is now in Balance Mode. Slowly step on with your other foot.

- 4 Stand with your weight evenly distributed on both feet and relax, looking straight ahead.

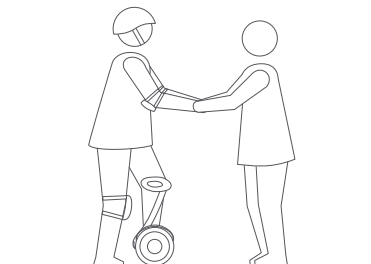
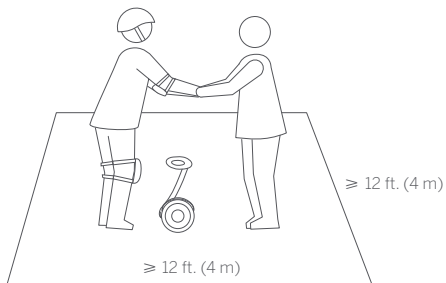

- 1 Go to a large open area and ask a friend to assist you on your first ride.

⚠ WARNING

Always step on/off from the back of the miniLITE.

- 2 Lightly place one foot on the foot mat, while keeping your other foot on the ground holding your weight. Do not press the steering bar with your leg.

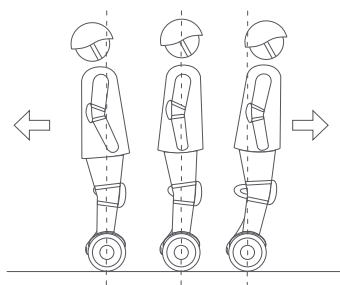

- 5 Gently lean your body forward and backward to control your movement.

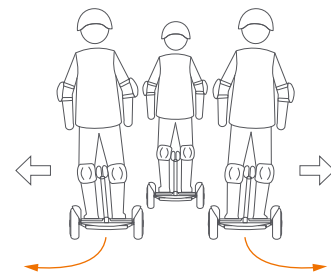

- 6 To turn, gently lean left or right against the steering bar.

8 Warning

 You must read and understand the Warnings and Safe Riding instructions in this manual before attempting to ride the miniLITE. Failure to follow these warnings could result in death or serious injury due to: loss of balance, traction, and/or control; collisions; and falls.

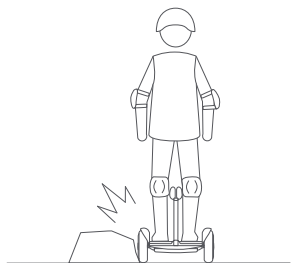

 Avoid contacting obstacles with the tire/wheel.

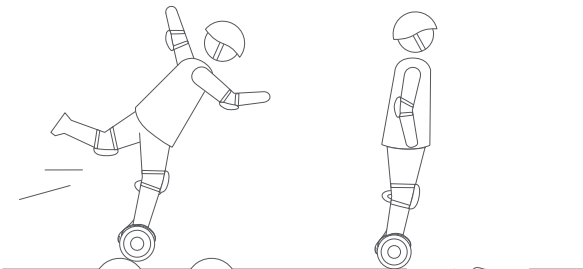

 When traversing small bumps or uneven terrain, maintain a moderate speed of 2-6 mph (3-10 km/h) and keep your knees bent. Do not go too slow or too fast; otherwise you may lose control and fall.

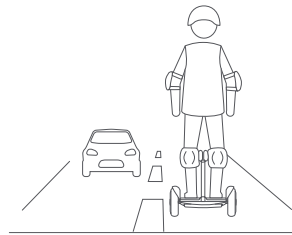

 Do not ride on public roads, motorways, highways, or streets.

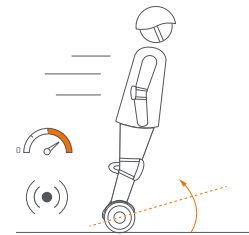

 Do not accelerate when the miniLITE tilts back or sounds an alarm. Do not attempt to override the speed limiter.

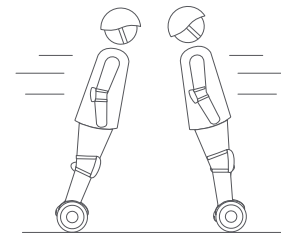

 Do not accelerate or decelerate abruptly. Do not lean more than 5° or accelerate/decelerate faster than 2.5 mph/s (4 km/h/s).

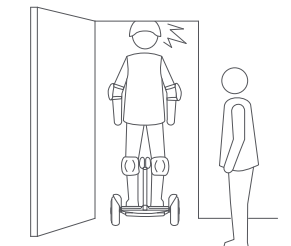

 Watch your head when passing through doorways.

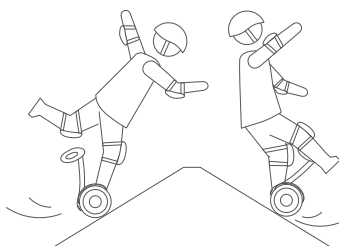

 Avoid slopes steeper than 15°. Avoid slopes steeper than 10° when payload is greater than 176 lbs (80 kg).



 Do not ride through puddles or other bodies of water. Do not get wet.

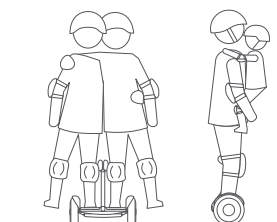

 The miniLITE is for one rider only. Do not ride double or carry any passengers. Do not carry a child.

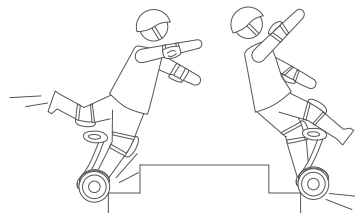

 Do not ride over holes, curbs, steps, or other obstacles.

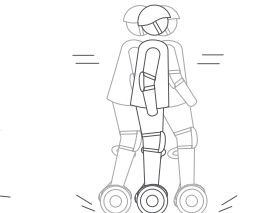

 Do not rock back and forth or shift your weight abruptly.

⚠ Warning

You must read and understand the Warnings and Safe Riding instructions in this manual before attempting to ride the miniLITE. Failure to follow these warnings could result in death or serious injury due to: loss of balance, traction, and/or control; collisions; and falls.

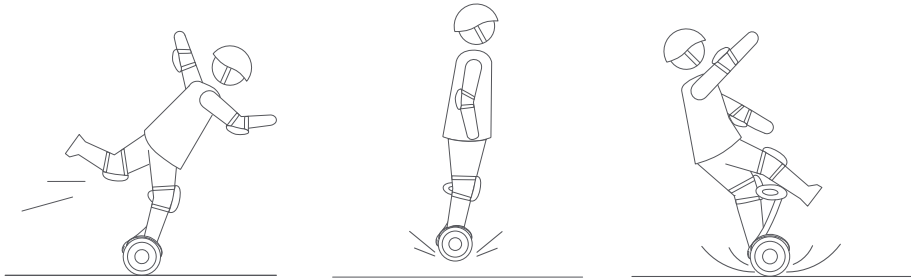

⚠ Do not attempt stunts of any kind. Always keep both feet on the foot mats.

⚠ Maintain contact with the ground at all times. Do not jump or attempt stunts.

⚠ Do not ride on low traction surfaces (including, but not limited to, wet ground, loose sand, loose gravel, and ice).

9 Features

Power Assist Mode

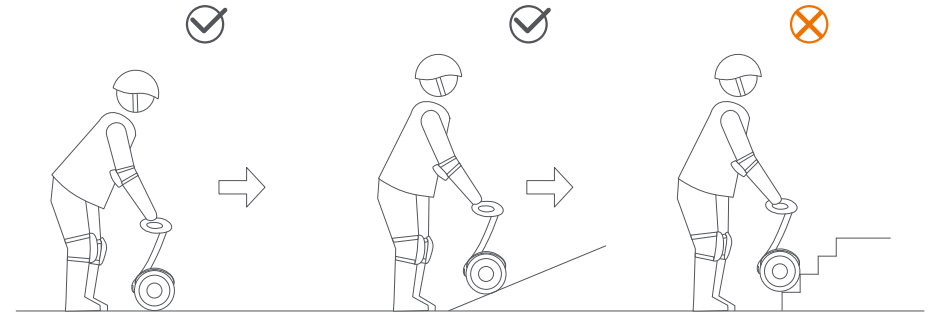

When your miniLITE is powered on, but no rider is standing on it, it is in Power Assist Mode. Steer the miniLITE across smooth surfaces using the steering bar. Do not guide it up stairs, across potholes, over large cracked/uneven surfaces, or over other obstacles; guide your miniLITE around the obstacle or carry it over the obstacle as shown above.

10 Maintenance

Cleaning and Storing Your miniLITE

Use a soft, wet cloth to wipe the mainframe clean. Hard to remove dirt can be scrubbed with a toothbrush and toothpaste, then cleaned with a soft, wet cloth. Scratches on plastic parts can be polished with extra fine grit abrasive paper.

NOTE

Do not wash your miniLITE with alcohol, gasoline, acetone, or other corrosive/volatile solvents. These substances may damage the appearance and internal structure of your miniLITE. Do not wash your miniLITE with a power washer or high pressure hose.

⚠ WARNING

Make sure the miniLITE is powered OFF, the charging cable is unplugged, and the rubber cap on the charge port is tightly sealed before cleaning; otherwise you may expose yourself to electric shock or damage the electronic components.

Store your miniLITE in a cool, dry place. Do not store it outdoors for extended periods of time. Exposure to sunlight and temperature extremes (both hot and cold) will accelerate the aging process of the plastic components and may reduce battery life.

Tire Pressure

Inflate tires to 45–50 psi. Inflate both tires equally.

Battery Pack Maintenance

Do not store or charge the battery at temperatures outside the stated limits (see Specifications). Do not discard or destroy the battery. For more battery information, refer to the sticker on the battery itself, located on the bottom of the miniLITE. Refer to your local laws and regulations regarding battery recycling and/or disposal.

A well maintained battery can perform well even after many miles of riding. Charge the battery after each ride and avoid draining the battery completely. When used at room temperature (70°F [22°C]) the battery range and performance is at its best; whereas using it at temperatures below 32°F (0°C) can decrease range and performance. Typically, at -4°F (-20°C) range can be half that of the same battery at 70°F (22°C). Battery range will recover when temperature rises. More details are available in the App.

NOTE

Typically, a fully charged battery should retain charge for 120-180 days in Standby Mode. Remember to charge the battery after each use. Completely draining the battery may cause permanent damage to the battery. Electronics inside the battery record the charge-discharge condition of the battery; damage caused by over-discharge or under-discharge will not be covered by the Limited Warranty.

⚠ WARNING

Do not attempt to disassemble the battery. Risk of fire. No user serviceable parts.

⚠ WARNING

Do not ride when the ambient temperature is outside the machine operation temperature(see Specifications) because low/high temperature will limit the maximum power/torque. Doing so could cause personal injury or property damage due to slips or falls.

11 Specifications

	Item	N4M160 Parameters
Dimensions	Unit	21.6×10.4×23.2 in (548×263×590 mm)
	Payload	22–176 lbs (10–80 kg)
Weight	Net	Approx. 27.6 lbs (12.5 kg)
	Recommended Age	6+ years old. See the weight limit
Rider	Required Height	3'7"–5'11" (110–180 cm)
	Machine Parameters	Max. Speed
Typical Range ¹		Approx. 11 miles (18 km)
Max. Slope		10° (80 kg payload) 15° (70 kg payload)
Traversable Terrain		Pavement, packed dirt, slopes < 10°, obstacles < 0.4 in (1 cm), gaps < 1.2 in (3 cm)
Operating Temperature		14–104°F (-10–40°C)
Storage Temperature		-4–122°F (-20–50°C)
IP Rating		Mainframe IP54/ Battery pack IPx6
Charge Time		Approx. 3 hours
Battery	Nominal Voltage	36 VDC
	Max. Charging Voltage	42 VDC
	Charging Temperature	32–104°F (0–40°C)
	Nominal Capacity	155 Wh
	Continuous Discharge Power ²	1147 W
Motors	Battery Management System	Over-voltage, under-voltage, short circuit, and over-heating protection. Auto-sleep and auto-wake.
	Nominal Power	350×2 W
	Max. Power	700×2 W

[1] Typical Range: tested while riding under full power, 132 lbs (60 kg) load, 77°F (25°C), 6-8 mph (10-13 km/h) average speed on pavement.

[2] Continuous Discharge Power: tested while under full power at 77°F (25°C). The value changes with temperature and remaining battery capacity. For example, the continuous discharge power drops to ~80% of the maximum value at 10% remaining battery capacity, and the continuous discharge power drops to ~70% of the maximum value at 32°F (0°C).

Charger	Output Power	71 W
	Input Voltage	100-240 V AC ~ 50/60 Hz
	Output Voltage	42 VDC
	Output Current	1.7 A
	Charging Temperature	32–104°F (0–40°C)

12 Certifications

This product has been tested and passed ANSI/CAN/UL-2272.
The battery complies with UN/ DOT 38.3

Federal Communications Commission (FCC) Compliance Statement for USA

This device complies with part 15 of the FCC rules. Operation is subject to the following two conditions: (1) This device may not cause harmful interference, and (2) this device must accept any interference received, including interference that may cause undesired operation.

NOTE

This equipment has been tested and found to comply with the limits for a Class B digital device, pursuant to part 15 of the FCC Rules. These limits are designed to provide reasonable protection against harmful interference in a residential installation. This equipment generates, uses and can radiate radio frequency energy and, if not installed and used in accordance with the instructions, may cause harmful interference to radio communications. However, there is no guarantee that interference will not occur in a particular installation. If this equipment does cause harmful interference to radio or television reception, which can be determined by turning the equipment off and on, the user is encouraged to try to correct the interference by one or more of the following measures:

- Reorient or relocate the receiving antenna.
- Increase the separation between the equipment and receiver.
- Connect the equipment into an outlet on a circuit different from that to which the receiver is connected.
- Consult the dealer or an experienced radio/TV technician for help.

This equipment complies with FCC radiation exposure limits set forth for an uncontrolled environment.

Industry Canada (IC) Compliance Statement for Canada

This device complies with Industry Canada license-exempt RSS standard (s). Operation is subject to the following two conditions: (1) this device may not cause interference, and (2) this device must accept any interference, including interference that may cause undesired operation of the device.

CAN ICES-3 (B)/NMB-3(B)

Neither Segway Inc. nor Ninebot is responsible for any changes or modifications not expressly approved by Segway Inc. or Ninebot. Such modifications could void the user's authority to operate the equipment.

Segway miniLITE (model N4M160)

FCC ID: 2ALS8-NA2468

IC: 22636-NA2468

European Union Compliance Statement

Battery recycling information for the European Union



Batteries or packaging for batteries are labeled in accordance with European Directive 2006/66/EC concerning batteries and accumulators and waste batteries and accumulators. The Directive determines the framework for the return and recycling of used batteries and accumulators as applicable throughout the European Union. This label is applied to various batteries to indicate that the battery is not to be thrown away, but rather reclaimed upon end of life per this Directive. In accordance with the European Directive 2006/66/EC, batteries and accumulators are labeled to indicate that they are to be collected separately and recycled at end of life. The label on the battery may also include a chemical symbol for the metal concerned in the battery (Pb for lead, Hg for mercury, and Cd for cadmium). Users of batteries and accumulators must not dispose of batteries and accumulators as unsorted municipal waste, but use the collection framework available to customers for the return, recycling, and treatment of batteries and accumulators. Customer participation is important to customers for the return, recycling, and treatment of batteries and accumulators. Customer participation is important to minimize any potential effects of batteries and accumulators on the environment and human health due to the potential presence of hazardous substances.

Restriction of Hazardous Substances Directive (RoHS)

Ninebot products sold in the European Union, on or after 3 January 2013 meet the requirements of Directive 2011/65/EU on the restriction of the use of certain hazardous substances in electrical and electronic equipment ("RoHS recast" or "RoHS 2").

Radio and Telecommunications Terminal Equipment Directive



European Union Contact Address:

EU Contact Address for regulatory topics only: Hogehilweg 8, 1101CC, Amsterdam, The Netherlands

Hereby, Ninebot (Tianjin) Tech Co., Ltd. declares that the wireless equipment listed in this section are in compliance with the essential requirements and other relevant provisions of Directive 2014/53/EU.

13 Trademark and Legal Statement

Segway and the Rider Design are trademarks of Segway Inc., registered in the U.S. and other countries; Segway miniLITE, miniLITE and Ninebot by Segway are trademarks of Segway Inc.; Ninebot is a trademark of Ninebot (Tianjin) Tech Co. Ltd., registered in the U.S. and other countries; Android, Google Play and the Google Play logo are trademarks of Google Inc.; Apple and the Apple logo are trademarks of Apple Inc., registered in the U.S. and other countries. App Store is a service mark of Apple Inc., registered in the U.S. and other countries. The respective owners reserve the rights of their trademarks referred to in this manual.

The miniLITE is covered by relevant patents. For patent information go to <http://www.segway.com>.

We have attempted to include descriptions and instructions for all the functions of the miniLITE at the time of printing. However, your miniLITE may differ slightly from the one shown in this document. Visit the Apple App Store (iOS) or the Google Play Store (Android) to download and install the App.

Please note that there are multiple Segway and Ninebot by Segway models with different functions, and some of the functions mentioned herein may not be applicable to your unit. The manufacturer reserves the right to change the design and functionality of the miniLITE product and documentation without prior notice.

© 2017 Ninebot (Beijing) Tech Co. Ltd. All rights reserved.

14 Contact

Contact us if you experience issues relating to riding, maintenance and safety, or errors/faults with your miniLITE.

Americas:

Segway Inc.

14 Technology Drive, Bedford, NH 03110, USA

Tel : 1-603-222-6000

Fax: 1-603-222-6001

Toll Free: 1-866-473-4929

E-mail Sales: customeroperation@segway.com

E-mail Service: technicalsupport@segway.com

Website: www.segway.com

Europe, Middle East and Africa:

Segway Europe B.V.

Hogehilweg 8, 1101CC, Amsterdam, The Netherlands

Email service: service@segway.eu.com

Website: www.segway.com

Have your Segway miniLITE's serial number on hand when contacting Segway.

You can find your serial number on the skid plate on the underside of your miniLITE or in the App under More Settings → Basic Information.