

# USER MANUAL



The manufacturer reserves the right to make changes to the Ninebot S, release firmware updates, and update this manual at any time.

Visit [www.segway.com](http://www.segway.com) to download the latest user materials and watch the safety video.

You must install the Segway-Ninebot App to follow the New Rider Tutorial, activate your Ninebot S, and obtain the latest updates and safety instructions.

[www.segway.com](http://www.segway.com)

V 1.0

**ninebot s**

# Contents

1. Riding Safety	03
2. Packing List	05
3. Diagram	06
4. Assembling	07
5. Charging	07
6. First Ride	08
7. Learning to Ride	09
8. Warnings	11
9. Lifting and Power Assist Mode	14
10. Maintenance	15
11. Specifications	16
12. Trademark & Legal Statement	17
13. Certifications	18
14. Contact	19

# Welcome

Thanks for choosing the Ninebot S!

To enjoy the many features of your Ninebot S you must read and follow these instructions.

Enjoy your ride!

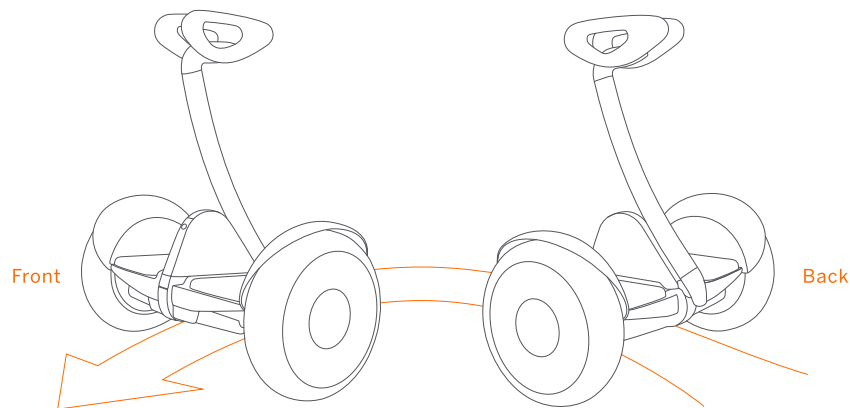

## ⚠ WARNING

Always step on/off from the back of the Ninebot S.  
Otherwise you risk falls and/or collisions because the steering direction is reversed.

# 1 Riding Safety

1. The Ninebot S is a recreational product. Before mastering riding skills, you need to practice. Neither Ninebot (means Ninebot (Beijing) Tech Co., Ltd. and its subsidiaries and affiliates) nor Segway Inc. is responsible for any injuries or damage caused by a rider's inexperience or failure to follow the instructions in this document.
2. Please understand that you can reduce the risk by following all the instructions and warnings in this manual, but you cannot eliminate all the risks. Remember that whenever you ride the Ninebot S you risk injury or death from loss of control, collisions, and falls. When entering into public spaces always comply with the local laws and regulations. As with other vehicles, faster speeds require longer braking distance. Sudden braking on smooth surfaces could lead to wheel slip, loss of balance, or falls. Be cautious and always keep a safe distance between you and other people or vehicles when riding. Be alert and slow down when entering unfamiliar areas.
3. Always wear a helmet when riding. Use an approved bicycle or skateboard helmet that fits properly with the chin strap in place, and provides protection for the back of your head.
4. Do not attempt your first ride in any area where you might encounter children, pedestrians, pets, vehicles, bicycles, or other obstacles and potential hazards.
5. Respect pedestrians by always yielding the right of way. When approaching a pedestrian from the front, stay to the right and slow down. Avoid startling pedestrians. When approaching from behind, announce yourself and slow down to walking speed when passing. Pass on the left whenever possible. Please obey local traffic laws and regulations.
6. In places without laws and regulations governing self-balancing electric vehicles, comply with the safety guidelines outlined in this manual. Neither Ninebot nor Segway Inc. is responsible for any property damage, personal injury/death, accidents, or legal disputes caused by violations of the safety instructions.
7. Do not allow anyone to ride your Ninebot S on his/her own unless he/she has carefully read this manual, watched the safety video, and followed the New Rider Tutorial on the Segway-Ninebot App. The safety of new riders is your responsibility. Assist new riders until they are comfortable with the basic operation of the Ninebot S. Make sure each new rider wears a helmet and other protective gear.
8. Before each ride check for loose fasteners, damaged components, and low tire pressure. If the Ninebot S makes abnormal sounds or signals an alarm, immediately stop riding. Diagnose your Ninebot S via the Segway-Ninebot App and call your dealer/distributor for service.
9. Be alert! Scan both far ahead and in front of your Ninebot S — your eyes are your best tool for safely avoiding obstacles and low traction surfaces (including, but not limited to, wet ground, loose sand, loose gravel, and ice).
10. To reduce risk of injury, you must read and follow all "CAUTION" and "WARNING" notices in this document. Do not ride at an unsafe speed. Under no circumstance should you ride on roads with motor vehicles. The manufacturer recommends riders be 16+ years old. Always follow these safety instructions:
  - A. People who should not ride the Ninebot S include:
    - i. Anyone under the influence of alcohol or drugs.
    - ii. Anyone who suffers from disease that puts them at risk if they engage in strenuous physical activity.
    - iii. Anyone who has problems with balance or with motor skills that would interfere with their ability to maintain balance.
    - iv. Anyone whose height or weight is outside the stated limits (see Specifications).
    - v. Pregnant women.
  - B. Riders under the age of 16 years old should ride under adult supervision.
  - C. Comply with local laws and regulations when riding this product. Do not ride where prohibited by local laws.
  - D. To ride safely, you must be able to clearly see what is in front of you and you must be clearly visible to others.
  - E. Do not ride in the snow, in the rain, or on roads which are wet, muddy, icy, or that are slippery for any reason. Do not ride over obstacles (sand, loose gravel, or sticks). Doing so could result in a loss of balance or traction and could cause a fall.
  - F. Do not accelerate or decelerate suddenly. Do not accelerate when the Ninebot S tilts back or sounds an alarm. Do not attempt to override the speed limiter.
11. Do not attempt to charge your Ninebot S if it, the charger, or the power outlet is wet.
12. As with any electronic device, use a surge protector when charging to help protect your Ninebot S from damage due to power surges and voltage spikes. Only use the Ninebot supplied charger. Do not use a charger from any other product.
13. Use only Ninebot or Ninebot approved parts and accessories. Do not modify your Ninebot S. Modifications to your Ninebot S could interfere with the operation of the Ninebot S, could result in serious injury and/or damage, and could void the Limited Warranty.
14. Do not sit on the steering bar. Doing so could result in serious injury and/or damage to your Ninebot S.

## 2 Packing List

Steering Bar

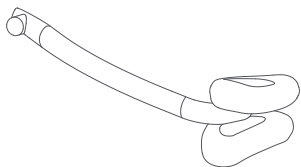

Mainframe

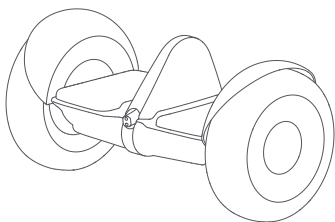

User Manual



Quick Start



Limited Warranty



Accessory Box

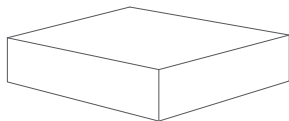

### Accessories in the Box

Screw × 2



Lid



Hex wrench



Air Valve Extension



Charger, Power Cord

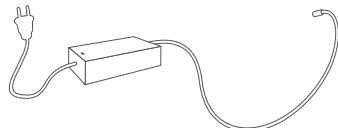

When unpacking your Ninebot S, please verify that the above items are included in the package. If you are missing any components, please contact your dealer/distributor or email [technicalsupport@segway.com](mailto:technicalsupport@segway.com). After verifying that all components are present and in good condition, you can assemble your new Ninebot S. Please retain the box and packaging materials in case you need to ship your Ninebot S in the future. Remember to power off your Ninebot S and unplug the charge cable before assembling, mounting accessories, or cleaning the mainframe.

## 3 Diagram

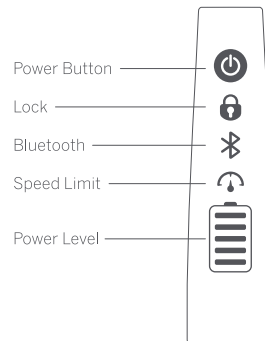

Power Button

Lock

Bluetooth

Speed Limit

Power Level

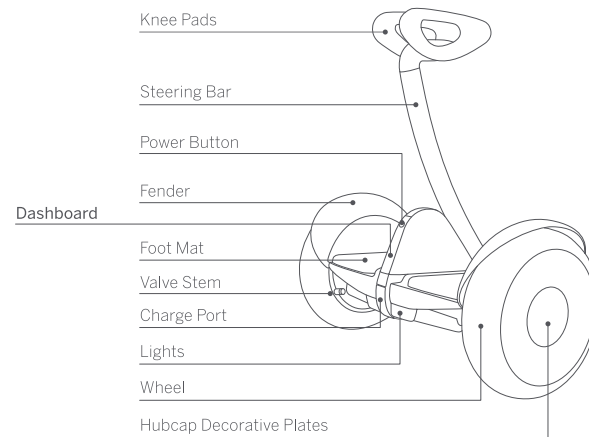

Knee Pads

Steering Bar

Power Button

Fender

Dashboard

Foot Mat

Valve Stem

Charge Port

Lights

Wheel

Hubcap Decorative Plates



Power Button

Turn ON/OFF. The Ninebot S will automatically power OFF when idle for 10 minutes, or when laid down (horizontal) for over 30 seconds.



Lock

Enable Lock Mode via the App. The Ninebot S will vibrate, flash its lights, and sound an alarm if anyone moves it. The App will also alarm. The Ninebot S will not balance in Lock Mode.



Bluetooth

When Bluetooth is enabled but not connected to a smart phone, this icon will blink. When the Segway-Ninebot App is connected to the Ninebot S, this icon will glow steadily.



Speed Limit

Enable and adjust Speed Limit Mode via the App. When the icon is illuminated the Ninebot S is limited to 4.3 mph (7 km/h). This speed limit can be adjusted in the App. As you approach the speed limit, the Ninebot S tilts back.



Power Level

Indicates the remaining battery life. When the battery is nearly empty this icon blinks and the Ninebot S beeps, indicating that you need to charge your Ninebot S. When less than 30%, your Ninebot S will gradually reduce the max speed limit. Use the App to read the remaining power and estimated remaining range.

## 4 Assembling

- 1 Insert the steering bar into the steering socket at the back of the mainframe.
- 2 Install the two screws. Tighten securely with the included hex wrench.
- 3 Snap the lid securely with hearing the sound of "click".

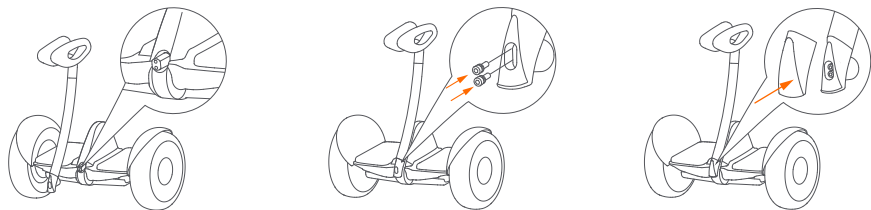

Check the Power ON/OFF status after assembly.

⚠ For your safety, your Ninebot S is not activated at this time and will beep occasionally after Power ON. Until activated, the Ninebot S maintains a very low riding speed and steering sensitivity, and should not be ridden. Install the Segway-Ninebot App on your mobile device (with Bluetooth 4.2 or above), connect to the Ninebot S with Bluetooth, and follow the App instructions to activate your Ninebot S and follow the training procedures.

## 5 Charging

⚠ Do not connect the charger if the charge port or charge cable is wet. The battery pack is only to be charged by adults.

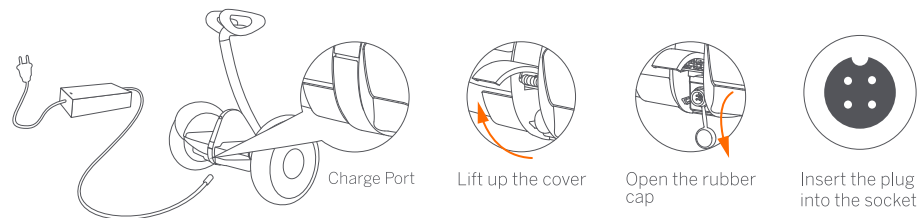

• Your Ninebot S is fully charged when the LED on the charger changes from red (charging) to green (trickle charge). Close the rubber cap when not charging.

## 6 First Ride



⚠ There are safety risks when learning to ride the Ninebot S. You must read the Safety Instructions and follow the New Rider Tutorial in the App before your first ride.

For your safety, your Ninebot S is not activated at this time and will beep occasionally after Power ON. Until activated, the Ninebot S maintains a very low riding speed and steering sensitivity, and should not be ridden. Install the App on your mobile device (with Bluetooth 4.2 or above), connect to the Ninebot S with Bluetooth, and follow the App instructions to activate your Ninebot S and follow the training procedures.

Scan the QR code to download the App (iOS 8.0 or above, Android™ 4.3 or above).



1 Install App and register/login.

2 Power ON the Ninebot S. The Bluetooth icon blinking indicates the Ninebot S is waiting for a connection.

3 In the APP, click Vehicle, scan and select your Ninebot S. The Ninebot S will beep when the connection is successful. The Bluetooth icon will stop blinking and remain illuminated.

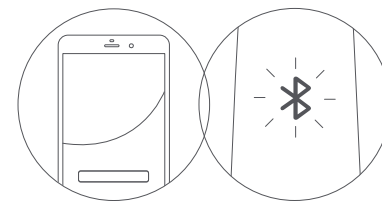

## 7 Learning to Ride

### ⚠ WARNING

Rider must weigh 88–220 lbs (40–100 kg) and must be 4'3"–6'6" (130–200 cm) tall.

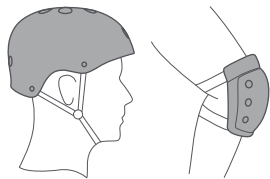

Wear an approved helmet and other protective gear to minimize any possible injury.

After activation, the App will lead you through the New Rider Tutorial. Please follow the instructions in the App and in this manual.

### NOTE

You must first download the Segway-Ninebot App on your mobile device. The App will lead you through the New Rider Tutorial.

For your safety, the Ninebot S will limit the max speed to 4.3 mph (7 km/h) until you complete the New Rider Tutorial. For the first 0.6 miles (1 km) after completing the New Rider Tutorial, the max speed will be limited to 6.2 mph (10 km/h), after which you can disable the speed limiter via the App and reach a maximum speed of 10 mph (16 km/h).

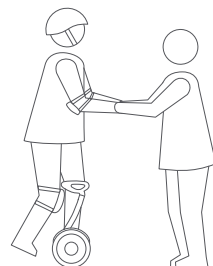

3 Slowly transfer your weight onto the Ninebot S. The unit will beep, indicating it is now in balance mode. Slowly step on with your other foot.

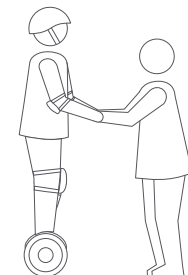

4 Stand with your weight evenly distributed on both feet and relax, looking straight ahead.

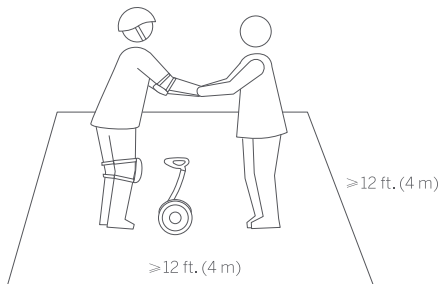

1 Go to a large open area and ask a friend to assist you on your first ride.

### ⚠ WARNING

Always step on/off from the back of the Ninebot S.

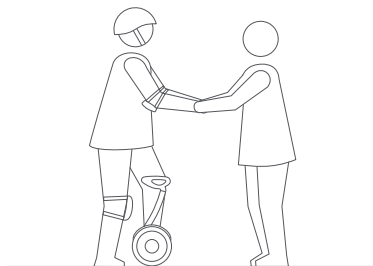

2 Place one foot on the foot mat, with your other foot still on the ground holding your weight. Do not press the steering bar with your leg.

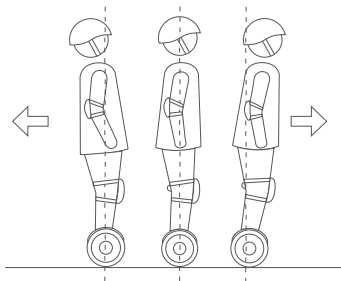

5 Gently lean your body forward and backward to control your movement.

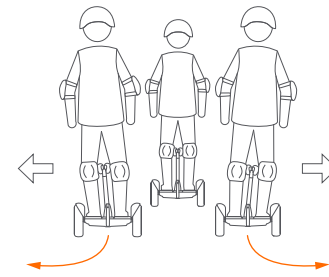

6 To turn, gently lean left or right against the steering bar.

## 8 Warnings

**⚠** You must read and understand the Warnings and Safe Riding instructions in this manual before attempting to ride the Ninebot S. Failure to follow these warnings could result in death or serious injury due to: loss of balance, traction, and/or control; collisions; and falls.

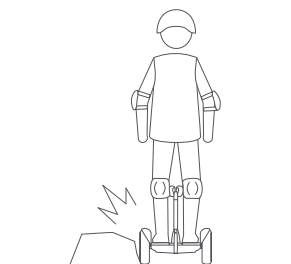

**⚠** Avoid contacting obstacles with the tire/wheel.

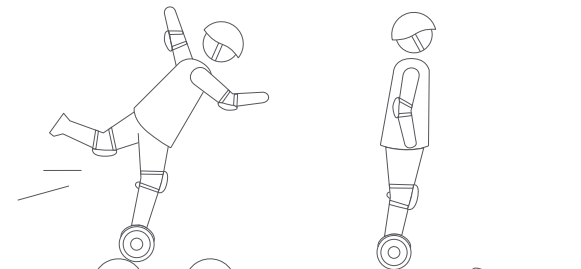

**⚠** When traversing small bumps or uneven terrain, maintain a moderate speed of 2-6 mph (3-10 km/h) and keep your knees bent. Do not go too slow or too fast; otherwise you may lose control and fall.

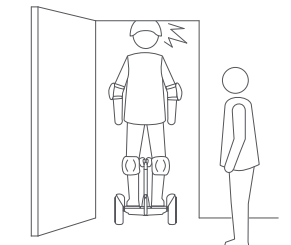

**⚠** Watch your head when passing through doorways.

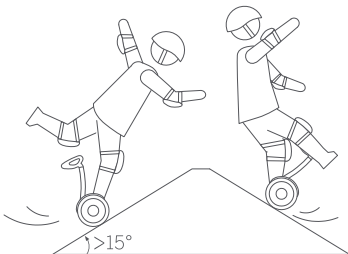

**⚠** Avoid slopes steeper than 15° or you may lose traction.



**⚠** Do not ride through puddles or other bodies of water. Do not get wet.

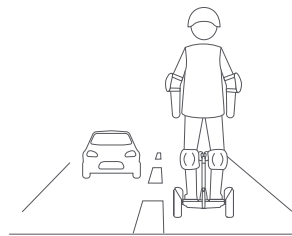

**⚠** Do not ride on public roads, motorways, highways, or streets.

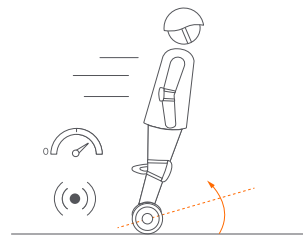

**⚠** Do not accelerate when the Ninebot S tilts back or sounds an alarm. Do not attempt to override the speed limiter.

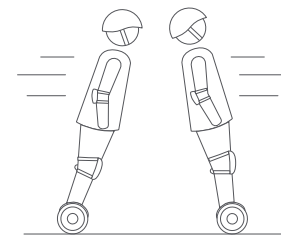

**⚠** Do not accelerate or decelerate abruptly. Do not lean more than 5° or accelerate/decelerate faster than 2.5 mph/s (4 km/h/s).

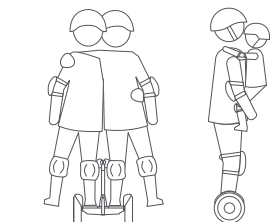

**⚠** The Ninebot S is for one rider only. Do not ride double or carry any passengers. Do not carry a child. Do not ride when pregnant.

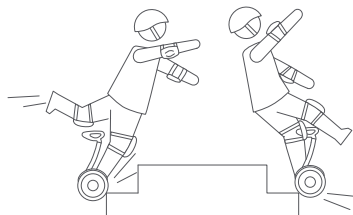

**⚠** Do not ride over holes, curbs, steps, or other obstacles.

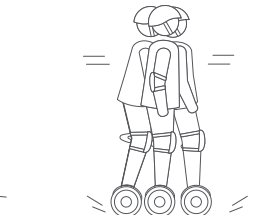

**⚠** Do not rock back and forth or shift your weight abruptly.

## ⚠ Warnings

You must read and understand the Warnings and Safe Riding instructions in this manual before attempting to ride the Ninebot S.

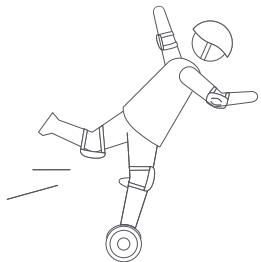

⚠ Do not attempt stunts of any kind. Always keep both feet on the foot mats.

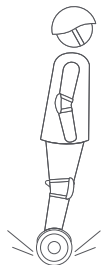

⚠ Maintain contact with the ground at all times. Do not jump or attempt stunts.

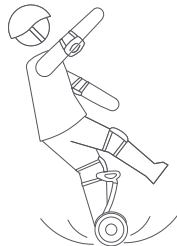

⚠ Do not ride on low traction surfaces (including, but not limited to, wet ground, loose sand, loose gravel, and ice).

## 9 Lifting and Power Assist Mode

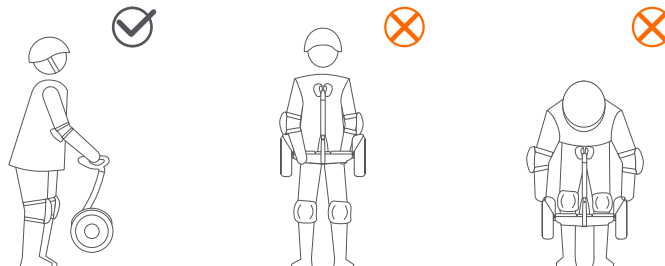

Lifting

For your safety, motor power is cut off when the Ninebot S is lifted off the ground in Balance Mode. When the Ninebot S is put back down it will begin balancing again. Do not lift the Ninebot S by the fenders or mainframe; you risk pinching or injuring your fingers/hands. Please lift via the steering bar as shown above.

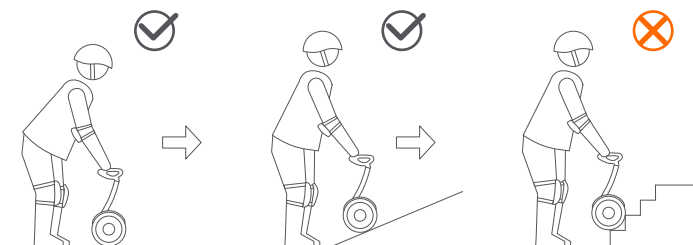

Power Assist Mode

When your Ninebot S is powered on, but no rider is standing on it, it is in Power Assist Mode. Steer the Ninebot S across smooth surfaces using the steering bar. Do not guide it up stairs, across potholes, over large cracked/uneven surfaces, or over other obstacles; guide your Ninebot S around the obstacle or carry it over the obstacle as shown above.



## 10 Maintenance

### Cleaning and Storing Your Ninebot S

Use a soft, wet cloth to wipe the mainframe clean. Hard to remove dirt can be scrubbed with a toothbrush and toothpaste, then cleaned with a soft, wet cloth.

### NOTE

The IP Rating of the mainframe is IP54, IP Rating of the battery pack is IPX6. Do not wash your Ninebot S with alcohol, gasoline, acetone, or other corrosive/volatile solvents. These substances may damage the appearance and internal structure of your Ninebot S. Do not wash your Ninebot S with a power washer or high pressure hose.

### ⚠ WARNING

Prolonged exposure to UV rays, rains and the elements may damage the enclosure materials, store indoors when not in use or during charging. (Une exposition prolongée aux rayons UV, à la pluie et aux éléments peut endommager les matériaux du boîtier. Il est donc nécessaire de ranger l'appareil à l'intérieur lorsque vous ne l'utilisez pas ou lorsque vous le chargez.) Make sure the Ninebot S is powered OFF, the charging cable is unplugged, and the rubber cap on the charge port is tightly sealed before cleaning; otherwise you may expose yourself to electric shock or damage the electronic components. Store your Ninebot S in a cool, dry place. Do not store it outdoors for extended periods of time. Exposure to sunlight and temperature extremes (both hot and cold) will accelerate the aging process of the plastic components and may reduce battery life.

### Battery Pack Maintenance

Do not store or charge the battery at temperatures outside the stated limits (see Specifications). Do not expose the battery to fire. Do not discard or destroy the battery. Refer to your local laws and regulations regarding battery recycling and/or disposal.

A well maintained battery can perform well even after many miles of riding. Charge the battery after each ride and avoid draining the battery completely. When used at room temperature (70°F [22°C]) the battery range and performance is at its best; whereas using it at temperatures below 32°F (0°C) can decrease range and performance. Typically, at -4°F (-20°C) range can be half that of the same battery at 70°F (22°C). Battery range will recover when temperature rises.

### NOTE

Typically, a fully charged battery should retain charge for 120-180 days in Standby Mode. Remember to charge the battery after each use. Completely draining the battery may cause permanent damage to the battery. Electronics inside the battery record the charge-discharge condition of the battery; damage caused by over-charging or under-charging will not be covered by the Limited Warranty.

### ⚠ WARNING

Do not attempt to disassemble the battery. Risk of fire. No user serviceable parts. (Risque d'incendie. Il n'y a pas d'éléments pouvant être réparés par l'utilisateur.)

### ⚠ WARNING

Do not ride when the ambient temperature is outside the machine operation temperature (see Specifications) because low/high temperature will limit the maximum power/torque. Doing so could cause personal injury or property damage due to slips or falls.

### Recommended tire pressure

Inflate tires to 45–50 psi. Inflate both tires equally.

## 11 Specifications

Category	Item	N3M240 Parameters
Dimensions	Length × width	260×548 (mm)
	Height <sup>[1]</sup>	595 (mm)
Weight	Payload	88–220 lbs (40–100 kg)
	Net weight	Approx. 28 lbs (12.8 kg)
Rider Requirements	Ages	16 ~ 50 years
	Height	4'3"–6'6" (130–200 cm)
Vehicle	Maximum speed	Approx. 10 mph (16 km/h)
	Typical range <sup>[2]</sup>	Approx. 13.7 mi (22 km)
	Maximum range	Approx. 15*
	Beginner mode	Will be automatically disabled after you have traveled 1 km. You can re-enter beginner mode at any time through the App
	Traversable terrain	Hard roads, flat concrete roads, slopes of less than 15 degrees, steps not higher than 1 cm, and dips no more than 3 cm wide
	Operating temperature	14–104°F (-10–40°C)
	Storage temperature	-4–122°F (-20–50°C)
	Permitted charging temperature	32–104°F (0–40°C)
	IP rating	IP54
Battery Pack	Rated voltage	54.8 V $\overline{\text{---}}$
	Maximum charging voltage	59.5 V $\overline{\text{---}}$
	Rated capacity	236 Wh
	Smart BMS	Overvoltage/ Under voltage/Short Circuit/Overheating Protection, Auto-Sleep/Wake-up, detailed information of battery can be checked with App.
	Maximum continuous discharge power <sup>[3]</sup>	1000 W
Motor	Charging Temperature	32–104°F (0–40°C)
	Rated power	400×2 W
	Maximum power	800×2 W
App connection	Compatible with	Android 4.3; iOS 8.0 or later
	Wireless Connectivity	Bluetooth 4.2

[1] Vehicle height: The distance from the ground to the highest point of the vehicle body.

[2] Typical range: Tested while riding under full power, 154 lbs (70 kg) load, 77°F (25°C), 9.3 mph (15 km/h) average speed on pavement.

[3] Continuous Discharge Power: Tested while under full power at 77°F (25°C). The value changes with temperature and remaining battery capacity.

For example, the continuous discharge power drops to ~80% of the maximum value at 10% remaining battery capacity, and the continuous discharge power drops to ~70% of the maximum value at 32°F (0°C).

Note: The tilde symbol (~) indicates that the following number is an approximation.

Charger	Model Number	HT-A10-120W-59.5V
	Manufacturer	Chingmi (Beijing) Technology Co., Ltd.
	Input voltage	100 – 240 V ~
	Output voltage	Approx. 59.5 V = = =
	Rated power	120 W
	Charging time	Approx. 3 h
	Output Current	2 A
	Charging Temperature	32–104°F (0–40°C)
	Compliance	FCC/UL

## 12 Trademark & Legal Statement

Ninebot is registered trademark of Ninebot (Tianjin) Tech. Co., Ltd; Ninebot S is trademark of Ninebot (Tianjin) Tech. Co., Ltd; Segway is registered trademark of Segway Inc; Apple and Apple Logo are registered trademark of Apple Inc in the United States and elsewhere. App Store is service mark of Apple Inc; Android is trademark of Google Inc. Android robots was originally created by Google Inc; The respective owners reserve the rights of their trademarks referred to in this manual.

The Ninebot S is covered by relevant patents. For patent information go to <http://www.segway.com>.

We have attempted to include descriptions and instructions for all the functions of the Ninebot S at the time of printing. However, your Ninebot S may differ slightly from the one shown in this document. Please note that there are multiple Ninebot models with different functions, and some of the functions mentioned herein may not be applicable to your unit. The manufacturer reserves the right to change the design and functionality of the Ninebot S product and documentation without prior notice.

© 2018 Ninebot (Beijing) Tech Co., Ltd. All rights reserved.

## 13 Certifications

### Ninebot S N3M240

- UL2272
- FCC part 15 subparts B and C

### Batteries

- UL2271
- UN/DOT 38.3

### Federal Communications Commission (FCC) Compliance Statement for USA

This device complies with part 15 of the FCC rules. Operation is subject to the following two conditions: (1) This device maynot cause harmful interference, and (2) this device must accept any interference received, including interference that maycause undesired operation.

Note:This equipment has been tested and found to comply with the limits for a Class B digital device, pursuant to part 15 of the FCC Rules. These limits are designed to provide reasonable protection against harmful interference in a residential installation. This equipment generates, uses and can radiate radio frequency energy and, if not installed and used in accordance with the instructions, may cause harmful interference to radio communications. However, there is no guarantee that interference will not occur in a particular installation. If this equipment does cause harmful interference to radio or television reception, which can be determined by turning the equipment off and on, the user is encouraged to try to correct the interference by one or more of the following measures:

- Reorient or relocate the receiving antenna,
- Increase the separation between the equipment and receiver.
- Connect the equipment into an outlet on a circuit different from that to which the receiver is connected,
- Consult the dealer or an experienced radio/TV technician for help.

This equipment complies with FCC radiation exposure limits set forth for an uncontrolled environment.

### Industry Canada (IC) Compliance Statement for Canada

This device complies with Industry Canada license-exempt RSS standard(s). Operation is subject to the following two conditions: (1) this device may not cause interference, and (2) this device must accept any interference, including interference that may cause undesired operation of the device.

### CAN ICES-3 (B)/NMB-3(B)

Ninebot is not responsible for any changes or modifications not expressly approved by Ninebot. Such modifications could void the user's authority to operate the equipment.

FCCID:2AF2B-NB  
IC:20915-NB01  
Model Number: N3M240

## 14 Contact

Contact us if you experience issues relating to riding, maintenance and safety, or errors/faults with your Ninebot S.

Segway Inc.

14 Technology Drive, Bedford, NH 03110, USA

Tel: 1-603-222-6000

Fax: 1-603-222-6001

Toll Free: 1-866-473-4929

E-mail Sales: [customeroperation@segway.com](mailto:customeroperation@segway.com)

E-mail Service: [technicalsupport@segway.com](mailto:technicalsupport@segway.com)

Website: [www.segway.com](http://www.segway.com)

Have your Ninebot S's serial number on hand when contacting Segway.

You can find your serial number on the bottom of your Ninebot S.