

N

USER MANUAL



Attach the
SN Code here

The SN Code of your scooter.
Please see P.7 and P.8 for
detailed information.

CONTENTS

General Notice	1
Precautions	2
Safety Notice	3
Installation Guide.....	4
Downloading the App	7
Parts Info.....	9
Dashboard Display Info.....	11
Operation Guide.....	14
Battery Use and Maintenance Guide.....	21
DOs and DON'Ts while Riding	25
Maintenance and Repair.....	27
Regular Maintenance Checklist	30
Technical Parameters	37
Maintenance Record.....	41

General Notice

- △ Please read this User Manual carefully for proper operation before riding the scooter.
- △ For your safety, please check whether the parts are in good condition according to this User Manual before riding. Contact your dealer in time in case of any problems.
- △ Please follow the traffic laws. Slow down on slippery roads in bad weather to allow greater braking distance for your safety.
- △ Please pay attention to deep water. It may cause rusting or failure of the motor, battery, or other parts if water level reaches wheel axle.
- △ Do not dismantle the scooter on your own. Please contact your dealer for replacement or purchase of original parts.
- △ For others' safety and preventing unnecessary damage to your scooter, do not lend your scooter to those who can't operate.
- △ Please keep the User Manual properly.

Precautions

- △ Rider and Passenger

This scooter is not designed for a ride of more than 2 persons.

- △ Road Conditions

This scooter is not designed for off-road use.

- △ This User Manual should be deemed as a permanent document of This scooter. If this scooter is transferred to others, this User Manual should also be handed over to the new owner.
- △ Reproduction or reprint of any part of this User Manual is strictly prohibited.

Attention: Do not exceed speed limit and apply brakes cautiously. Always use side stand or central stand when parking.

Warning: Failure to follow the instructions herein may lead to serious casualties, personal injury, or scooter damage.

Safety Notice

- △ Using a helmet and protective goggles is strongly advised.
- △ You are advised to take proper training or exercise before using on open roads.
- △ Please follow the Operation Guide (P.14) to fully understand how to properly operate the scooter.
- △ It should be noted that the braking distance in bad weather will be much longer. Please avoid braking on paint markers, manhole covers, and oil stains to prevent slipping. Pay extra attention when riding through railway crossings, junctions, tunnels, and bridges. Slow down if road conditions are unclear.
- △ Do not use high beam indiscriminately. Continuous use of high beam may disturb the vision of other drivers and pedestrians.
- △ Do not use mobile phones or other electronic devices which may draw your attention while riding.
- △ Do not change the lane without signaling. Changing the lane at will is one of the major causes for accidents. When you need to change the lane, remember to switch on the Turn Signal Indicator first. Always check the vehicles approaching from behind before changing the lane.

Installation Guide

- ① Insert the key to the main lock and turn to the icon of "OPEN" as shown in the right figure.

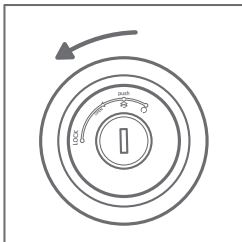

- ② Open the saddle to take out the key box, windshield package (with rubber pads and standard parts), and installation tools.

Insert the key into the keyhole in the rear storage and turn it to open the battery compartment. Take out the charger and rearview mirrors package inside.

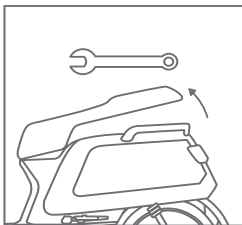

Installation Guide

- ③ Take out the rearview mirrors and check them carefully. Install the left rearview mirror into the mounting hole on the left brake lever and turn it clockwise. The bolt shall be screwed in for more than 15mm.

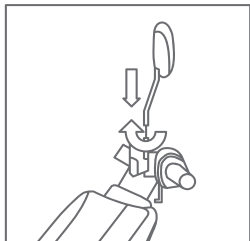

- ④ Adjust the rearview mirrors to an appropriate position and then tighten nuts on the rearview mirror with a spanner. Properly set the dust cover.

Install the right rearview mirror in the same way.

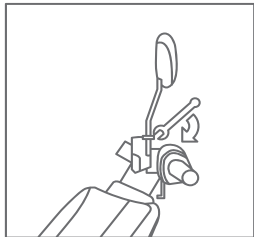

- ⑤ Align the windshield rubber part with the windshield holes and then install it.
- ⑥ Tighten the two screws with the screwdriver to secure the windshield.

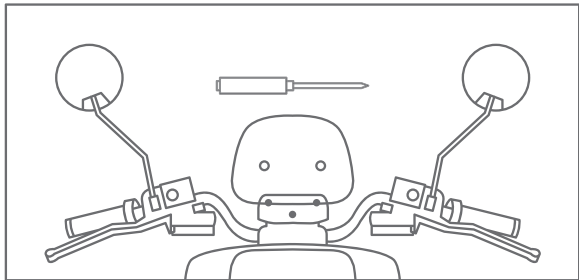

Downloading the APP

Functions such as checking battery level, locating, and management can be implemented on the electric scooter through the app.

- ① Scan the QR code below to download the APP titled *Niu E-Scooter*.



- ② Run Setup after downloading and register.
- ③ Please scan the QR code **on the inside of cover page** for app registration.

Note:

The mobile phone system is required to be at least Android 4.0 or iOS 8. Make sure that the mobile phone has been connected to the Internet when running the app (Wi-Fi / 2G / 3G / 4G).



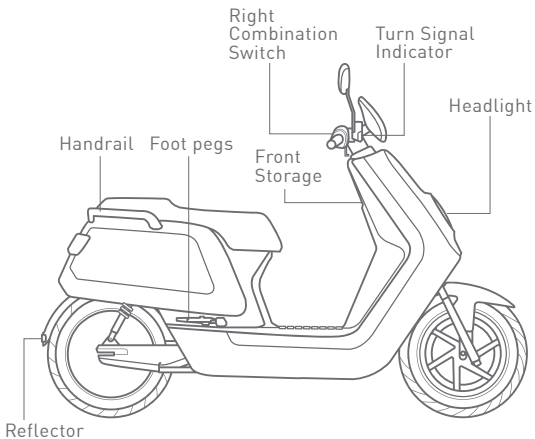

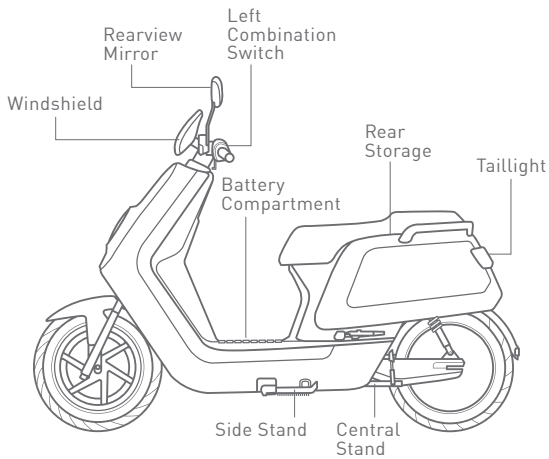



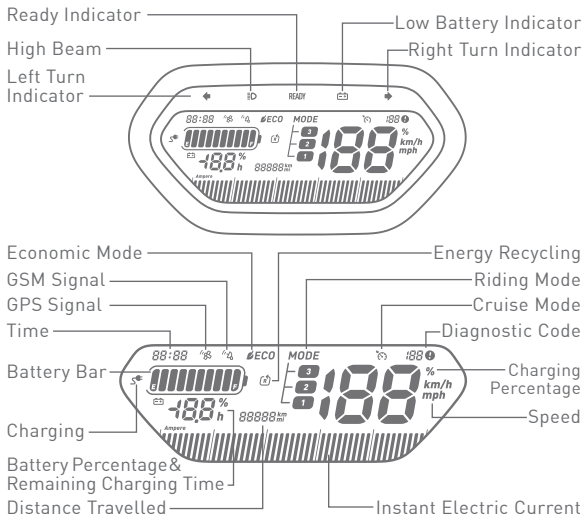



Parts Info





Dashboard Display Info



	Left Turn Indicator	The Left Turn Indicator is on.
	Right Turn Indicator	The Right Turn Indicator is on.
	High Beam	The High Beam is on.
	Ready Indicator	In Riding Mode.
	Low Battery Indicator	Battery level less than 10%.
	Time	Now is 10:00
	Economic Mode	Ideal energy consumption status.
	GPS Signal	No flashing: Signal strong. Bars are flashing: Signal weak.
	GSM Signal	Entire icon flashing: No signal.
	Cruise Mode	The scooter is in Cruise Mode.
	Diagnostic Code	The Diagnostic Code is 30. Please see P.34-37 for details.
	Energy Recycling Status	Energy is being recycled from braking.

Dashboard Display Info



Battery Bar

Current battery level is 80~89%.

85%

Battery Percentage
(Small)

Current battery level is 85%.

- 3.2h

Remaining Charging
Time

The remaining charging time is
3.2h (using scooter charging port).



Charging

Battery is being charged.

00802 km

Distance Travelled

Distance Travelled is 802km.



Instant Electric
Current

Indicates instant power output.

MODE



Riding Mode

Mode 2 is selected.

26 km/h

Speed

Current speed is 26km/h.

13%

Charging Percentage
(Large)

Current battery charging progress
is 13% (using scooter charging
port).

Operation Guide

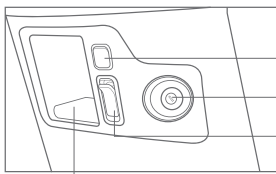

△ Front Storage Area

- ① USB Charging Port
- ② Main Lock
- ③ Hook
- ④ Front Storage

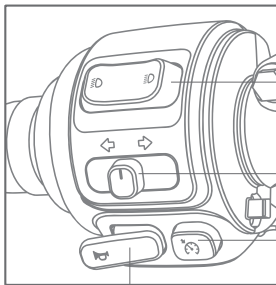

△ Left Combination Switch

- ① High/Low Beam Light
- ② Turn Signal Indicator
- ③ Cruising Mode
- ④ Horn

Operation Guide

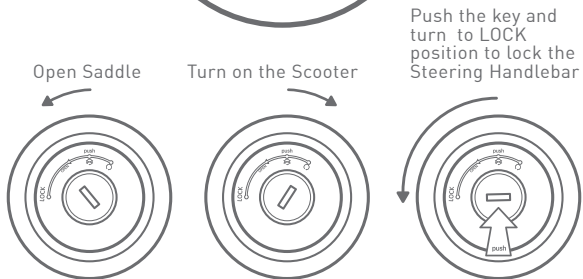
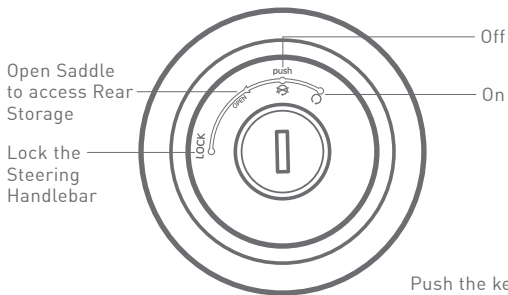

- ① High/Low Beam: Press the right part to switch to high beam; press the left part to switch to low beam.

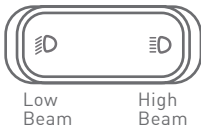

Remarks: To signal overtaking with flashing light, the rider may press and release the left part of the button repeatedly.

- ② Turn Signal Indicator: Push the button left to turn on the Left Turn Signal Indicator; push the button right to turn on the Right Turn Signal Indicator. Press the button to turn off.

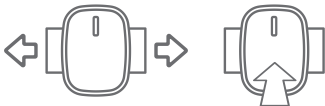

- ③ Cruising Mode: Push the button to cruise at current speed. Press again or brake to turn it off.



Operation Guide

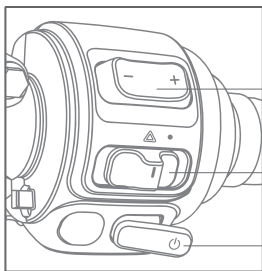

△ Right Combination Switch

- ① Mode Selector
- ② Hazard Light Switch
- ③ Start/Stop Button

- ① Mode Selector: Press right part to switch up the mode. Press left part to switch down the mode.

Switch down



Switch up

- ② Hazard Light Switch: Push the switch left to turn on the Hazard Light; push the switch right to turn it off.

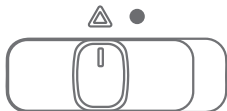

Turn on the Hazard Light



Turn off the Hazard Light

- ③ Start/Stop Button: Press and hold the button for 2 seconds to set the scooter in the riding mode. The **READY** indicator on the dashboard will light up and you are ready to go. Press the button again to turn it off.



Operation Guide

△ Start the Scooter

- ① Press the Unlock button of the remote controller. After the Turn Signal Indicators flash twice, the scooter is unlocked.
- ② After the scooter is unlocked, insert the key into the Keyhole and turn clockwise to  position.
- ③ After system diagnostic, hold the brake and press the Start Button for 2 seconds.
- ④ The **READY** indicator will light up. Release the brake and the scooter will be ready to go.

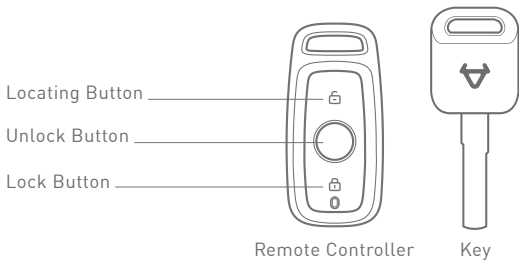

△ **Locking Steering Handlebar**

Turn the steering handlebar to the left, then push the key inward and turn it anticlockwise to LOCK position.

△ **Locking with Remote Controller**

The scooter can only be locked when the scooter is turned off. Press the Lock Button on the Remote Controller within an effective distance to turn on the Alarm. The Turn Signal Indicators will stay on for 2 seconds after the scooter is properly locked.

△ **Locating**

Press the Locating Button and the Turn Signal Indicators will flash for 10 seconds. If no further operation during this period, the Alarm will be on for 10 seconds. The Alarm can be cancelled by pressing the Unlock or Lock Button.

Battery Use and Maintenance Guide

△ Using Environment

- ① In order to prevent possible leakage, overheat, smoking, fire or explosion, please follow these instructions:
- ② The battery should be used at the temperature of -10°C to 45°C.
- ③ Do not expose to water, beverages or corrosive liquids.
- ④ Keep away from heat source, open fire, inflammable and explosive gases and liquids.
- ⑤ Please keep metal parts away from the battery compartment.

In case of undesirable odor, overheat or deformation of the battery, please disuse the battery immediately, keep away from the battery and contact your dealer.

Warning: The battery is not a repairable part by the user. In case of battery fault, please contact your dealer. Users dismantling the battery may lead to leakage, overheat, smoking, fire or explosion. This will invalidate product warranty

△ Charging Environment

The battery should be charged at the temperature of 10°C to 35°C. The charging time should not exceed 24 hours, or it will shorten the battery life. Do not charge the battery outdoors.

Attention: Do not charge the battery below 0°C.

Warning: Using non-original battery chargers may lead to leakage, overheat, smoking, fire or explosion.

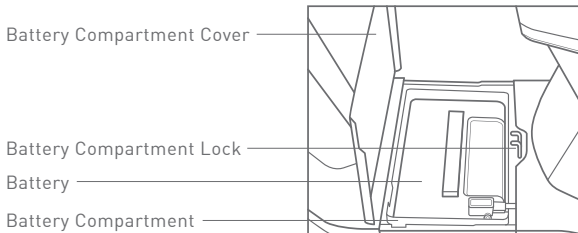

Battery Use and Maintenance Guide

△ Charging Methods

Charging on the Scooter

- ① Open the saddle with the key, plug the charging plug into the charging port.
- ② After the charging indicator turns from green to red, charging is started.
- ③ Turn on the scooter during charging to show the progress on the dashboard.

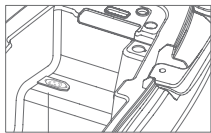

Charging Port on the Scooter

Charging on the Battery

- ① Remove the battery from the scooter.
- ② Connect the charger with battery and socket. When the charger indicator light is red, the battery is being charged.
- ③ After the charger indicator light turns from red to green, charging is completed.

Battery Charging Port

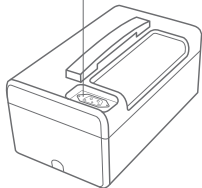

Warning:

- △ All operation should be strictly conform to the user manual. If not, result will be assumed by user.
- △ Must use original charger.
- △ Pay attention to the type of battery and applied voltage. Mixture use is forbidden.
- △ Charging should be in ventilated environment. DO NOT charge in closed space or under high temperature. DO NOT put charger into trunk or tail box while charging.
- △ While charging, connect battery with charger before connect with electric supply. After fully charged, disconnect the electric supply before unplug the battery plug.
- △ When the green light turns on, disconnect the power in time.
- △ Avoid long time connection between charger and AC power supply while not charging.
- △ While charging, if the signal light is abnormal, has odor, or the charger is over temperature, please stop charging immediately and check or change the charger in time.
- △ When using and storing the charger, please avoid foreign matter, especially water or other liquid in case of internal short circuit.
- △ DO NOT bring charger within scooter, if have to, please make sure of damping.
- △ DO NOT disassemble or change the parts in charger by yourself.

Attention:

- △ If the battery can not be fully charged after 12 hours, please stop charging and contact your dealer.
- △ To maximize the battery life, please keep the battery percentage within 20% to 80%.
- △ The battery will lose more capacity in lower temperature conditions. To be more specific, the usable capacity at -10°C is 70%, 85% at 0°C, and 100% at 25°C.
- △ The best battery capacity performance for storage is 50%. Storing battery with less than 10% or more than 90% over a long period of time will cause irreversible capacity loss to the battery.
- △ **The battery needs to take out from the scooter for storage longer than one week.** In this condition, please keep the battery at the temperature of 0°C to 20°C with capacity of 30%-70%. It's advised to have at least one cycle of charge and discharge every 2 months to minimize battery capacity loss during storage.
- △ **If the battery failure is due to misuse or lack of proper maintenance as instructed, its warranty will be invalidated.**
- △ Falling may cause uncontrollable internal damage to the battery and may cause leakage, overheat, smoking, fire or explosion.

DOs and DON'Ts while Riding

△ Before Riding

Please check the following details before riding.

Check Point	Description
Steering Handlebar	1) Steadiness 2) Steering flexibility 3) No axial displacement or loosening
Braking	1) Braking lever has 5 to 9mm idle travel.
Tyres	1) The air pressure range of the front tyre is 20 to 25psi; the air pressure range of the rear tyre is 26 to 32psi. 2) Proper tyre tread depth 3) No cracks or openings
Battery	Adequate for planned distance to travel
Lights	Check all the lights—High Beam, Low Beam, Brake Light, Turn Signal Indicator, etc.
Horn	Check whether the horn can work.

DOs and DON'Ts while Riding

△ Braking Precautions

Adjust the scooter upright before applying brakes. If the tyres are locked and the scooter loses steering ability resulting from excessive braking force, loosen the grip on the braking lever and the tyres will be working again and the scooter will be stabilized. Try to maintain a 1:1 ratio of front and rear braking force on slippery roads.

Caution:

For your safety, do not exceed the speed limit, use the brakes gently to maintain at safe speed while riding downhill.

Attention:

Inexperienced riders tend to use the rear brake only, which will accelerate the wear of the brake and result in a longer braking distance.

Warning:

Using the front brake or rear brake only is dangerous because of possible grip or control loss. Pay extra attention and use the brakes gently when riding on damp, slippery roads, and around corners. Otherwise, riders will be exposed to great danger.

Maintenance and Repair

Users are advised to have the scooter checked and maintained on a regular basis, even for the scooters that are not used for a long time.

△ **Regular Maintenance**

Users are advised to have their scooters checked 2 months after purchased or with 500 km travelled distance. Overall check and maintenance is advised to be conducted every 6 months or 3000km thereafter.

△ **Daily Maintenance**

If any problem occurs during checks, please look through the Home Repair Instructions or send the scooter to the dealer's for checks and maintenance.

△ **Scooter Washing**

Please always take out the battery before washing the scooter. Please use neutral detergent and water to wash the scooter. Use soft cloth to wipe the scooter after washing to prevent scratching.

Attention:

If the scooter is frequently used in overload, high-speed, bumpy or up/downhill riding conditions, the maintenance cycle should be shortened.

For more guaranteed quality and longer service life, please use original parts, which are under normal warranty.

Warning:

If incapable of repair or adjustment on his/her own, the scooter owner is advised to send the scooter to the dealer's for maintenance and adjustment for the sake of safety. Always choose a smooth surface road for repair and adjustment and unfold the central stand before repair and adjustment. If it's necessary to repair the scooter during a ride, mind the traffic.

Warning:

Do not use pressure washer to wash the scooter, especially around the battery compartment. Do not flush the rear inner mudguard, where the charger, controller and other parts are installed behind. If the charging port on the scooter is wetted, please do not charge before the charger dries off. Contacting your dealer is recommended.

Maintenance and Repair

△ Short-term Storage:

- ① Keep the scooter in flat, steady, well-ventilated and dry area.
- ② Charge the battery to 50% full before storage to maximize battery life.
- ③ Avoid exposure under sunlight and rain to reduce damage or aging.

△ Long-term Storage:

- ① Remember to have a charge and a discharge at least every 2 months and charge the battery to 50% full before storage to maximize battery life.
- ② Charge the battery to 100% full after long-term storage.
- ③ Check all the parts carefully to make sure that there is no problem before riding it. If there's any problem, take the scooter to your dealer for maintenance or repair.

Warning: Please disconnect the battery with the scooter during storage.

Regular Maintenance Checklist	
Regular Safety and Performance Check	Brakes
	Lights
	Horn
	Electric Parts
	Tyres
Structural Check	Lubrication
	Wheel Bearing
	Vibration Damper
	Central Stand
	Steering Bearing
Major Parts	Battery
	Main Wiring Harness
	Control System

Troubleshooting List		
Malfunction Description	Causes	Troubleshooting
No output when switched on	<ol style="list-style-type: none"> 1. Dead battery 2. Alarm failure 	<ol style="list-style-type: none"> 1. Charge the battery. 2. Contact your dealer for professional checks.
Motor failure when turning the twist grip after switched on	<ol style="list-style-type: none"> 1. Battery level is low 2. The power off switch is enabled when pulling the brake lever 3. The Parking Mode has not been turned off yet 	<ol style="list-style-type: none"> 1. Charge the battery. 2. Do not pull the brake lever when twisting the twist grip. 3. Check "Start the Scooter" section of this Manual.
Battery charge failure	<ol style="list-style-type: none"> 1. The plug of the battery not properly connected with the battery socket 2. Battery is overdischarged 	<ol style="list-style-type: none"> 1. Check whether the plug is loosened. 2. Contact your dealer for professional checks.

Troubleshooting List		
Malfunction Description	Causes	Troubleshooting
Dropping speed or range	<ol style="list-style-type: none"> 1. Low battery level 2. Under-inflation of tyres 3. Frequent braking and overload 4. Battery aging or normal capacity loss 5. Low battery capacity resulting from low temperature 	<ol style="list-style-type: none"> 1. Charge the battery. 2. Check the tyre inflation. 3. Develop good riding habits. 4. Replace the battery. 5. Normal situation.
Sudden stop during a ride	Dead battery	Charge the battery.
	Identify the fault causes in reference to the Diagnostic Codes on Dashboard. Contact your dealer if the troubleshooting methods listed in this manual is not working.	

Troubleshooting List		
Malfunction Description	Causes	Troubleshooting
00 displayed	Communication failure or Dashboard failure	<ol style="list-style-type: none"> 1. Disconnect the battery and reconnect it after 30 seconds. 2. Check whether the wires are loosened. 3. Contact your dealer for professional checks.
10 displayed	FOC Controller locked rotor	Stop the scooter and restart later.
11 displayed	FOC Controller undervoltage/ overvoltage	Stop the scooter and restart later.
12 displayed	FOC Controller overcurrent	Contact your dealer for professional checks.
13 displayed	FOC Controller over-temperature	Disconnect the battery and cool it down before reuse.
20 displayed	Motor overtemperature	Stop the scooter and restart when cooled down.

Troubleshooting List		
Malfunction Description	Causes	Troubleshooting
30 displayed	Battery overcharged	Turn on the headlight and hazard light to discharge until the code disappear.
31 displayed	Charging overcurrent	Stop charging the battery and check if the charger is failed.
32 displayed	Charging at low temperature	Take the battery indoor until back to normal operating temperature.
60 displayed	SIM card identification failure	Contact your dealer for professional checks.
62 displayed	GPS module failure	
63 displayed	GPS antenna short circuit	
64 displayed	GPS antenna open circuit	
65 displayed	ECU SN missing/incorrect	

Troubleshooting List		
Malfunction Description	Causes	Troubleshooting
67 displayed	SIM card unpaid/ inactivated/low signal strength	Contact your dealer for professional checks.
99 displayed	Electronic components communication failure	Contact your dealer for professional checks.
110 displayed	FOC Controller failure	Contact your dealer for professional checks.
111 displayed	1. The scooter is locked 2. FOC Controller verification failure	1. Press unlock button on the Remote. 2. Contact your dealer for professional checks.
120 displayed	Motor failure	Contact your dealer for professional checks.
130 displayed	Battery overdischarged	Charge the battery.
131 displayed	Over-current discharging	Stop the scooter and restart later.

Troubleshooting List		
Malfunction Description	Causes	Troubleshooting
132 displayed	Battery overtemperature	Stop riding and let battery cool down.
133 displayed	Battery undertemperature	Charge the battery after it reaches the operating temperature range.
140 displayed	Twist grip failure	Please check the wires of the twist grip or contact your dealer for professional checks.
161 displayed	The scooter is locked by remote command	Contact your dealer for professional checks.
190 displayed	Controller communication failure	Contact your dealer for professional checks.
191 displayed	BMS communication failure	Contact your dealer for professional checks.

Technical Parameters

Key Features			
Product Weight	95Kg	Gradeability	Dynamic: 15°
Rated Voltage	60V	Maximum Designed Speed	Mode 1: 25km/h Mode 2: 30km/h Mode 3: 45km/h
Maximum Load	200Kg	Braking Distance	≤4.5m (30km/h)
Designed Capacity	2 Persons		

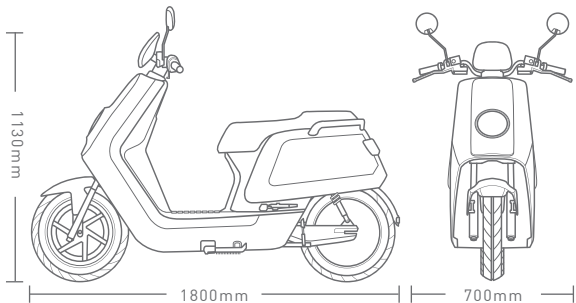

Technical Parameters

Frame	
Front Damper	Oil Damping Direct Acting Shock Absorber
Rear Damper	Oil Damping Direct Acting Shock Absorber
Front Tyre Specifications	90/90-12 Rim: 2.15x12
Rear Tyre Specifications	120/70-12 Rim: 3.50x12
Front Brake Mode	220 mm Dual-Piston Hydraulic Disk Brake
Rear Brake Mode	180 mm Dual-Piston Hydraulic Disk Brake
Minimum Ground Clearance	145mm
Seat Height	740mm

Battery System	
Voltage	60V
Capacity	29Ah
Standard Charging Current	4A
Maximum Discharging Current	40A

Power System	
Motor	Tailored Motor by Bosch GmbH
Motor Control Mode	FOC Vector Control
Max. Motor Continuous Power	25km/h Version: 800W, 1500W 45km/h Version: 1500W
Controller Maximum Current	40A

Electrical System	
Headlight	12V LED
Turn Indicator	12V LED
Taillight	12V LED
Brake Light	12V LED
Meter Panel	12V LCD
Central Control Unit	12V
USB Charging	5V/1A

Maintenance Record

Date		Mileage	
Notes			
Dealer			

Maintenance Record

Date		Mileage	
Notes			
Dealer			

Maintenance Record

Date		Mileage	
Notes			
Dealer			

Maintenance Record

Date		Mileage	
Notes			
Dealer			

Maintenance Record

Date		Mileage	
Notes			
Dealer			

Maintenance Record

Date		Mileage	
Notes			
Dealer			

Maintenance Record

Date		Mileage	
Notes			
Dealer			

Maintenance Record

Date		Mileage	
Notes			
Dealer			

