

# UQi Pro

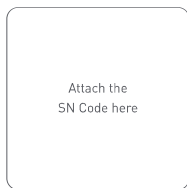

V 2.0

USER MANUAL



The SN Code of your scooter.  
Please see P.4 for detailed information.

## CONTENTS

General Notice .....	01
Precautions .....	02
Safety Notice .....	03
Download APP and Register .....	04
Installation Guide .....	05
Parts Info .....	07
Operation Guide .....	11
Battery Use and Maintenance .....	15
DOs and DON'Ts while Riding .....	21
Maintenance and Repair .....	23
Troubleshooting List .....	27
Technical Parameters .....	31
Maintenance Record .....	34

## General Notice

- Please read this User Manual carefully for proper operation before riding the scooter.
- For your safety, please check whether the parts are in good condition according to this User Manual before riding. Contact your dealer in time in case of any problems.
- Please follow the traffic laws. Slow down on slippery roads in bad weather to allow greater braking distance for your safety.
- Please pay attention to deep water. It may cause rusting or failure of the motor, battery, or other parts if water level reaches wheel axle.
- Do not dismantle the scooter on your own. Please contact your dealer for replacement or purchase of original parts.
- Do not lend your UQi Pro scooter to those who can't operate a scooter for others' safety and preventing unnecessary damage to your scooter.
- Please keep the User Manual properly.
- For more product information or maintenance need, please visit our website: [www.niu.com/en](http://www.niu.com/en)

## Precautions

- Rider and Passenger  
**UQi Pro scooter is designed for only 1 person.**
- Riding Conditions  
UQi Pro scooter is not designed for off-road use.
- This User Manual should be deemed as a permanent document of UQi Pro scooter. If this scooter is transferred to others, this User Manual should also be handed over to the new owner.
- Reproduction or reprint of any part of this User Manual is strictly prohibited.

**⚠ WARNING:** Do not exceed speed limit and apply brakes cautiously. Always use side stand when parking.

**⚠ ATTENTION:** Failure to follow the instructions herein may lead to serious casualties, personal injury, or scooter damage.

## Safety Notice

- Using a safety helmet and protective goggles is strongly advised.
- You are advised to take proper training or exercise before using on open roads.
- Please follow the Operation Guide (P.11) to fully understand how to properly operate the scooter.
- It should be noted that the braking distance in bad weather will be much longer. Please avoid braking on paint markers, manhole covers, and oil stains to prevent slipping. Pay extra attention when riding through railway crossings, junctions, tunnels, and bridges. Slow down if road conditions are unclear.
- Do not use high beam indiscriminately. Continuous use of high beam may disturb the vision of other drivers and pedestrians.
- Do not use mobile phones or other electronic devices which may draw your attention while riding.
- Do not change the lane without signaling. Changing the lane at will is one of the major causes for accidents. When you need to change the lane, remember to switch on the Turn Signal Indicator first. Always check the vehicles approaching from behind before changing the lane.

## Downloading the APP

Functions such as checking battery level, locating, and management can be implemented on the electric scooter through the app.

- Step 1** Scan the QR code below to download the APP titled Niu E-Scooter.
- Step 2** Run Setup after downloading and register.
- Step 3** Please scan the QR code on the inside of cover page for app registration.



### NOTE:

The mobile phone system is required to be at least Android 4.0 or iOS 8. Make sure that the mobile phone has been connected to the Internet when running the app (Wi-Fi / 2G / 3G / 4G).

## Installation Guide

- Step 1** Open the Accessories Box to take the tools.
- Step 2** Install the rearview mirrors into the mounting holes on dashboard and turn it clockwise. The bolt shall be screwed in for more than 15 mm.
- Step 3** Adjust the rearview mirror to an appropriate position and then tighten nuts on the rearview mirror with a spanner. Properly set the dust cover.

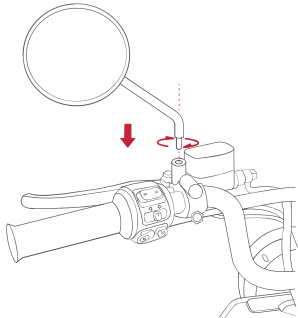

- Step 4** Take out the foot rests and assemble the top and holder together with screws for both sides with M6 screws.
- Step 5** Install the foot rests on two sides of the scooter frame with M6 screws.

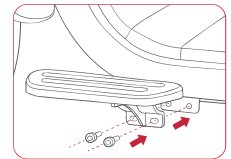
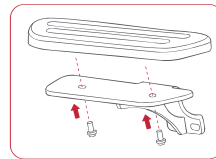

## Parts Info

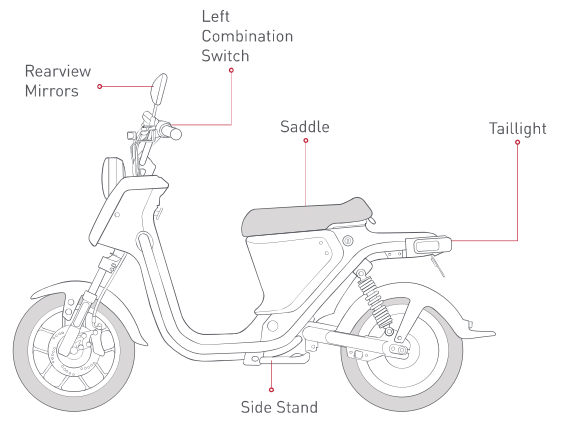
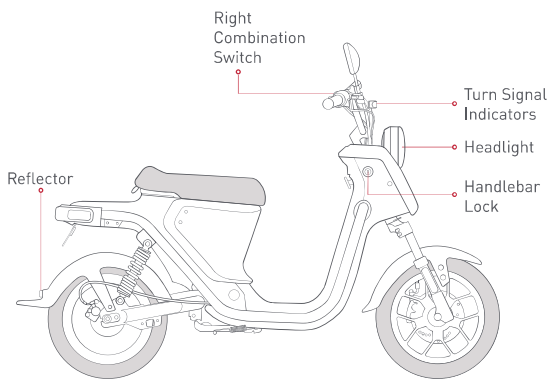



## Operation Guide

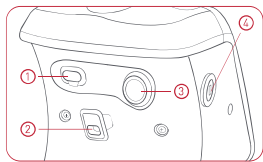

### Front Storage Area

- ① USB Port
- ② Hook
- ③ Power Button
- ④ Handlebar Lock

### Start the Scooter



Key



Remote Controller

- Unlock Button
- Power Button
- Lock Button

**Step 1** Press the Power Button of the scooter or the remote controller to turn on the scooter.

**Step 2** Press and hold the Start Button on the right handlebar for 2 seconds, **READY** on Dashboard will light on. You are ready to go.

### Unlocking the Scooter

Press the Unlock Button of the remote controller to disable the alarm. Insert the key into the keyhole of the handlebar lock, push inward, and turn clockwise to unlock the steering handlebar.

### Locking the scooter

Press the Power Button again to turn off the scooter. Turn the steering handlebar to the left, then Insert the key into the keyhole of the handlebar lock and turn counter-clockwise to lock steering handlebar. Press the Lock Button on the Remote Controller within an effective distance to turn on the alarm. The Turn Signal Indicators will stay on for 2 seconds after the scooter is properly locked.



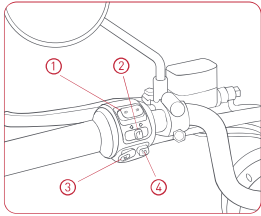

### Left Combination Switch

- ① High/Low Beam Light
- ② Turn Signal Indicator
- ③ Cruising Mode
- ④ Horn

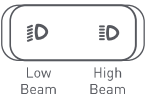

Low Beam High Beam

**High/Low Beam Light:** Press the right part to turn on the high beam; press the left part to turn on the low beam. To signal overtaking with flashing light, the rider may press and release the Pass button repeatedly.

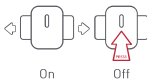

On Off

**Turn Signal Indicator:** Push the button left to turn on the Left Turn Signal Indicator; push the button right to turn on the Right Turn Signal Indicator. Press the button to reset and the Turn Signal Indicator will be off.



**Cruising Mode:** Push the button to cruise at current speed. Press again or brake to turn it off.

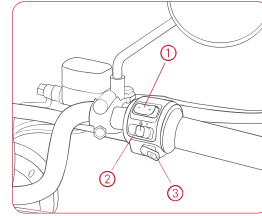

### Right Combination Switch

- ① Mode Switch
- ② Hazard Light Switch
- ③ Start Button



Switch down Switch up

**Mode Switch:** Press left part to switch to Mode 1[Eco Mode]. Press right part to switch to Mode 2[Sport Mode].

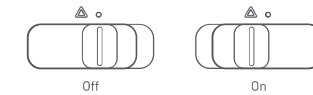

Off On

**Hazard Light Switch:** Push the switch to the left to turn on the Hazard Light; push again to turn it off.



**Start Button:** Press and hold the Start button for 2 seconds to start the scooter. The **READY** on the dashboard will light up. Press the button again to turn it off.

## Battery Use and Maintenance

### Battery Level Indicator

- When the Indicator Button is pressed, the Indicator will light up to show the percentage of the battery. The indicator has 5 sections. Each presents 20% of the battery level.
- If the battery level is less than 20%, the Indicator will flash 3 times.
- When charging, the indicator will flash to show the charging progress. They will stop flashing when the battery is fully charged.
- If all 5 sections flash, it means the battery has fault. Please contact your dealer for consultation.

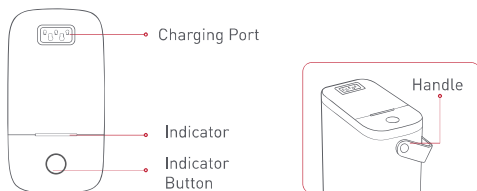

## Battery Use and Maintenance

### Using Environment

In order to prevent possible leakage, overheat, smoking, fire or explosion, please follow these instructions:

- The battery should be used at the temperature of -10°C to 45°C.
- Do not expose to water, beverages or corrosive liquids.
- Keep away from heat source, open fire, inflammable and explosive gases and liquids.
- Please keep metal parts away from the battery compartment.

In case of undesirable odor, overheat or deformation of the battery, please disuse the battery immediately, keep away from the battery and contact your dealer.

**⚠ WARNING:** The UQi Pro battery is NOT a repairable part by the user. In case of battery fault, please contact your dealer. Users dismantling the battery may lead to leakage, overheat, smoking, fire or explosion. Do not attempt to open or repair the battery, as any attempt to do so will render the warranty invalid.

### Charging Environment

The battery should be charged at the temperature of 10°C to 35°C. The charging time should not exceed 24 hours. Overcharging will shorten the battery life.

**⚠ ATTENTION:** Do not charge the battery below 0°C.

**⚠ WARNING:** Using non-original battery chargers may lead to leakage, overheat, smoking, fire or explosion.

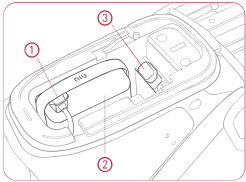

- ① Battery Connector
- ② Battery
- ③ Charging Port

### Charging Methods

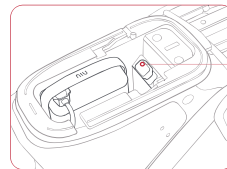

Charging Pot

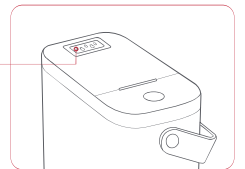

#### Charging on the Scooter

Open the saddle, open the cover of the connector, and plug the charger into the charging socket.

#### Charging the Battery

Remove the battery from the scooter. Connect the charger with battery and socket.

**⚠ WARNING**

- All operation should be strictly conform to the user manual. If not, result will be assumed by user.
- Must use original charger.
- Pay attention to the type of battery and applied voltage. Mixture use is forbidden.
- Charging should be in ventilated environment. DO NOT charge in closed space or under high temperature. DO NOT put charger into trunk or tail box while charging.
- While charging, connect battery with charger before connect with electric supply. After full charged, cut off the electric supply before cut off the battery plug.
- When the green light turns on, please cut off the power in time. Avoid long time connection between charger and AC power supply while not charging.
- While charging, if the signal light is abnormal, has different smell or the charger is over temperature, please stop charging immediately and check or change the charger in time.
- When using and storing the charger, please avoid foreign matter, especially water or other liquid in case of internal short circuit.
- DO NOT bring charger within scooter, if have to, please make sure of damping.
- DO NOT disassemble or change the parts in charger by yourself.

**⚠ ATTENTION**

- If the battery can not be fully charged after 12 hours, please stop charging and contact your dealer.
- To maximize the battery life, please keep the battery percentage within 20% to 80%.
- For storage, please keep the battery under 40°C to prevent irreversible capacity loss of the battery.
- UQi Pro battery will lose more capacity in lower temperature conditions. To be more specific, the usable capacity at -10°C is 70%, 85% at 0°C and 100% at 25°C.
- The best battery capacity performance for storage is 50%. Storing battery with less than 10% or more than 90% over a long period of time will cause irreversible capacity loss to the battery.
- **The battery needs to take out from the scooter for storage longer than one week.** In this condition, please keep the battery at the temperature of 0°C to 20°C with capacity of 30%-70%. It's advised to have at least one cycle of charge and discharge every 2 months to minimize battery capacity loss during storage.
- **If the battery failure is due to misuse or lack of proper maintenance as instructed, its warranty will be invalidated.**
- Falling may cause uncontrollable internal damage to the battery and may cause leakage, overheat, smoking, fire or explosion.

## DOs and DON'Ts while Riding

### Before Riding

Please check the following details before riding.

Check Point	Description
Steering Handlebar	[1] Steadiness [2] Steering flexibility [3] No axial displacement or loosening
Braking	Braking lever has 5 to 9mm idle travel.
Tyres	[1] The air pressure range of both tires is 25 to 34psi. [2] Proper tyre tread depth [3] No cracks or openings [4] Minimum load-capacity index: front 5, rear 27. [5] Minimum-speed category: B.
Battery	Adequate for planned distance to travel.
Lights	Check all the lights—High Beam, Low Beam, Brake Light, Turn Signal Indicator, etc.
Horn	Check whether the horn can work.

### Braking Precautions

Adjust the scooter upright before applying brakes.

If the tyres are locked and the scooter loses steering ability resulting from excessive braking force, loosen the grip on the braking lever and the tyres will be working again and the scooter will be stabilized.

Try to maintain a 1:1 ratio of front and rear braking force on slippery roads.

**⚠ ATTENTION:** Inexperienced riders tend to use the rear brake only, which will accelerate the wear of the brake and result in a longer braking distance.

**⚠ WARNING:** Using the front brake or rear brake only is dangerous because of possible grip or control loss. Pay extra attention and use the brakes gently when riding on damp, slippery roads and around corners. Otherwise, riders will be exposed to great danger.

## Maintenance and Repair

Users are advised to have the scooter checked and maintained on a regular basis, even for the scooters that are not used for a long time.

### Regular Maintenance

Users are advised to have their scooters checked 2 months after purchased or with 500 km travelled distance. Overall check and maintenance is advised to be conducted every 6 months or 3000 km thereafter.

### Daily Maintenance

If any problem occurs during checks, please look through the Home Repair Instructions or send the scooter to the dealer's for checks and maintenance.

### Scooter Washing

Please use neutral detergent and water to wash the scooter. Use soft cloth to wipe the scooter after washing to prevent scratching.

#### **⚠ ATTENTION**

If the scooter is frequently used in overload, high-speed, bumpy or up/downhill riding conditions, the maintenance cycle should be shortened.

For more guaranteed quality and longer service life, please use original parts, which are under normal warranty.

#### **⚠ WARNING**

If incapable of repair or adjustment on his/her own, the scooter owner is advised to send the scooter to the dealer's for maintenance and adjustment for the sake of safety. Always choose a smooth surface road for repair and adjustment. If it's necessary to repair the scooter during a ride, please mind the traffic.

#### **⚠ WARNING**

Do not use pressure washer to wash the scooter, especially around the battery compartment. Do not flush the rear inner mudguard, where the charger, controller and other parts are installed behind. If the charging port on the scooter is wetted, please do not charge before the charger dries off. Contacting your dealer is recommended.

## Storage Method

### Short-term Storage

- Keep the scooter in flat, steady, well-ventilated and dry area.
- Charge the battery to 50% full before storage to maximize battery life.
- Avoid exposure under sunlight and rain to reduce damage or aging.

### Long-term Storage

- Remember to have a cycle of charge and a discharge at least every 2 months and charge the battery to 50% full before storage to maximize battery life.
- Charge the battery to 100% full after long-term storage.
- Check all the parts carefully to make sure that there is no problem before riding it. If there's any problem, take the scooter to your dealer for maintenance or repair.

**⚠ WARNING:** Please take out the battery from the scooter when long-term storage.

Regular Maintenance Checklist	
Regular Safety and Performance Check	Brakes
	Lights
	Horn
	Electric Parts
	Tyres
Structural Check	Lubrication
	Wheel Bearing
	Vibration Damper
	Side Stand
	Steering Bearing
Major Parts	Battery
	Main Wiring Harness
	Control System

Troubleshooting List		
Malfunction Description	Causes	Troubleshooting
No output when switched on	<ol style="list-style-type: none"> <li>1. Dead battery</li> <li>2. Battery not connected</li> <li>3. Alarm failure</li> </ol>	<ol style="list-style-type: none"> <li>1. Charge the battery.</li> <li>2. Check if it's properly connected.</li> <li>3. Replace Alarm.</li> </ol>
Motor failure when turning the twist grip after switched on	<ol style="list-style-type: none"> <li>1. Battery voltage is low</li> <li>2. The power off switch is enabled when pulling the brake lever</li> <li>3. The Parking Mode has not been turned off yet</li> </ol>	<ol style="list-style-type: none"> <li>1. Charge the battery.</li> <li>2. Do not pull the brake lever when twisting the twist grip.</li> <li>3. Check "Start the Scooter" section. Check if the side stand is on.</li> </ol>
Battery charge failure	<ol style="list-style-type: none"> <li>1. Not properly connected</li> <li>2. Battery temperature is too high or too low</li> </ol>	<ol style="list-style-type: none"> <li>1. Check whether the plug is loosened.</li> <li>2. Wait for it to achieve normal temperature.</li> </ol>
Dropping speed or range	<ol style="list-style-type: none"> <li>1. Low battery level</li> <li>2. Under-inflation of tyres</li> <li>3. Frequent braking and overload</li> <li>4. Battery aging or normal capacity loss</li> <li>5. Low battery capacity resulting from low temperature</li> </ol>	<ol style="list-style-type: none"> <li>1. Charge the battery and check if the plug is properly plugged in and whether the charger is damaged.</li> <li>2. Check the tyre inflation every time.</li> <li>3. Develop good riding habits.</li> <li>4. Replace the battery.</li> <li>5. Normal situation.</li> </ol>

Troubleshooting List		
Malfunction Description	Causes	Troubleshooting
Sudden stop during a ride	Dead battery	Charge the battery.
	Identify the fault causes in reference to the meter panel fault codes.	
00 displayed	Communication failure or Dashboard failure	<ol style="list-style-type: none"> <li>1. Disconnect the battery and reconnect it after 30 seconds.</li> <li>2. Check whether the wires are loosened.</li> <li>3. Contact your dealer for professional checks.</li> </ol>
10 displayed	FOC Controller locked rotor	Stop the scooter and restart later.
11 displayed	FOC Controller undervoltage/overvoltage	Stop the scooter and restart later.
12 displayed	FOC Controller overcurrent	Contact your dealer for professional checks.
13 displayed	FOC Controller overtemperature	Disconnect the battery and cool it down before reuse.
20 displayed	Motor overtemperature	Stop the scooter and restart when cooled down.
30 displayed	Battery overcharged	Turn on the headlight and hazard light to discharge until the code disappear.
31 displayed	Charging overcurrent	Stop charging the battery and check if the charger is failed.



Troubleshooting List		
Malfunction Description	Causes	Troubleshooting
32 displayed	Charging at low temperature	Take the battery indoor until back to normal operating temperature.
60 displayed	SIM card identification failure	Contact your dealer for professional checks.
62 displayed	GPS module failure	
63 displayed	GPS antenna short circuit	
64 displayed	GPS antenna open circuit	
65 displayed	ECU SN missing/incorrect	
67 displayed	SIM card unpaid/inactivated/ low signal strength	
99 displayed	Electronic components communication failure	
110 displayed	FOC Controller failure	
111 displayed	1. The scooter is locked 2. FOC Controller verification failure	1. Press unlock button on the Remote. 2. Contact your dealer for professional checks.
120 displayed	Motor failure	Contact your dealer for professional checks.
130 displayed	Battery overdischarged	Charge the battery.
131 displayed	Over-current discharging	Stop the scooter and restart later.

Troubleshooting List		
Malfunction Description	Causes	Troubleshooting
132 displayed	Battery overtemperature	Stop riding and let battery cool down.
133 displayed	Battery undertemperature	Charge the battery after it reaches the operating temperature range.
140 displayed	Twist grip failure	Please check the wires of the twist grip or contact your dealer for professional checks.
161 displayed	The scooter is locked by remote command	Contact your dealer for professional checks.
190 displayed	Controller communication failure	
191 displayed	BMS communication failure	

## Technical Parameters

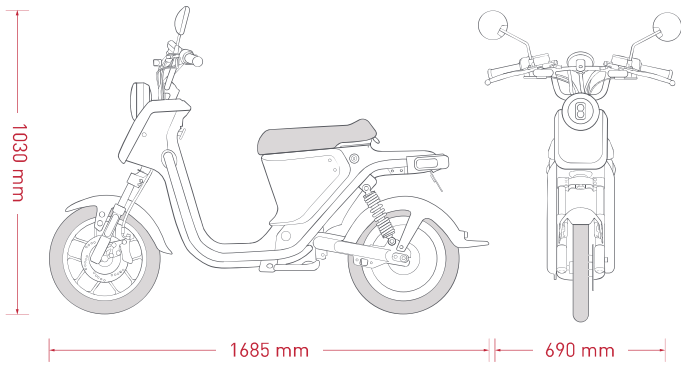

UQi Pro			
		40km/h	25km/h
Features	Dimension	1685 x 690 x 1030 mm	
	Product Weigh(battery included)	57kg	
	Maximum Load	147 kg	
	Designed Capacity	1 Person	
	Range	30 km ~ 40 km	
	Gradeability	Dynamic: ~9°	
Battery System	Max.Speed	40km/h	25km/h
	Voltage	48 V	
	Standard Charging Current	4 A	
	Maximum Discharging Current	40 A	
	Capacity	21 Ah	
Power System	Motor	Tailored Motor by Bosch GmbH	
	Motor Control Mode	FOC Vector Control	
	FOC Controller Max. Current	30 A	
	Motor Rated Power	800 W	
	Max. Motor Continuous Power	1200 W	1000 W
	Energy Consumption	29 Wh/Km	22 Wh/Km
Electrical System	Headlight/Turn/Indicator Taillight/Brake/Light Meter Panel	12V LED	
	Central Control Unit	12 V	
	USB Charging	5V/1A	

Frame	Front/Rear Damper	Oil Damping Direct Acting Shock Absorber
	Front Tyre Specification	65/95 - 12 Rim : 1.5 x 12
	Rear Tyre Specification	65/95 - 12 Rim : 1.5 x 12
	Front Brake Mode	180 mm Hydraulic Disk Brake
	Rear Tyre Pressure	158 mm Hydraulic Disk Brake
	Minimum Ground Clearance	160 mm
	Seat Height	710 mm

## Maintenance Record

Date	Mileage
<b>Notes:</b>	
<b>Dealer:</b>	

### Maintenance Record

Date		Mileage	
<b>Notes:</b>			
<b>Dealer:</b>			

### Maintenance Record

Date		Mileage	
<b>Notes:</b>			
<b>Dealer:</b>			

### Maintenance Record

Date		Mileage	
<b>Notes:</b>			
<b>Dealer:</b>			

### Maintenance Record

Date		Mileage	
<b>Notes:</b>			
<b>Dealer:</b>			

### Maintenance Record

Date		Mileage	
<b>Notes:</b>			
<b>Dealer:</b>			

### Maintenance Record

Date		Mileage	
<b>Notes:</b>			
<b>Dealer:</b>			